

**STAHLÉAN BRAZIL**  
SAVING LIVES



**Cardiovascular Instruments  
&  
Thoracic Instruments**



[www.stahleanbrazil.com](http://www.stahleanbrazil.com)

## Cardiovascular Instruments & Thoracic Instruments

Artery Clamps	3
Clamps	5
Bulldog Clamps	10
Scissors	11
Needle Holders	12
Retractors	13
Rib Spreaders	14
Rib Shears	17
Elevators	18



# ARTERY CLAMPS



## An Overview On

### Atraumatic Jaws

Also known as non-traumatic, atraumatic jaws will be mainly found in delicate surgery areas such as vascular and cardiothoracic. The design is such, that the surface area gripped is reduced, ensuring less trauma without the loss of grip.

Atraumatic jaws are available as straight or curved.

#### Atraumatic Jaw, Straight



#### Atraumatic Jaw, Curved



### Cooley Artery Clamps

Box joint, atraumatic, curved

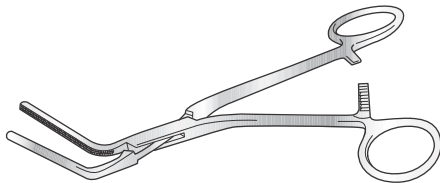

Code	Description
Sb-GI/071	160mm long
Sb-GI/072	200mm long

#### Large, curved 60°

Code	Description
Sb-GI/073	150mm long

#### Large, strongly curved 90°

Code	Description
Sb-GI/074	140mm long

#### Curved 30°

Code	Description
Sb-GI/075	160mm long

### DeBakey Bainbridge Clamps

Box joint, atraumatic, haemostatic

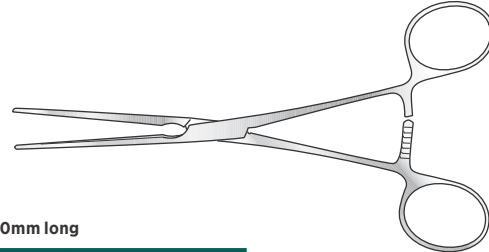

180mm long

Code	Description
Sb-GI/078	Straight
Sb-GI/077	Curved

### DeBakey Bainbridge Clamps

Box joint, atraumatic

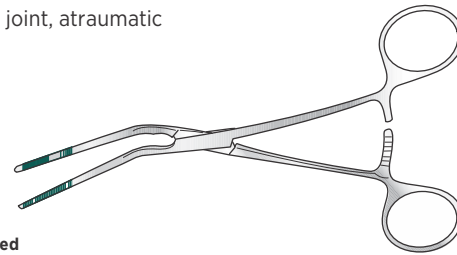

Curved

Code	Description
Sb-GI/079	165mm long

### DeBakey Bainbridge Clamps

Box joint, atraumatic, haemostatic

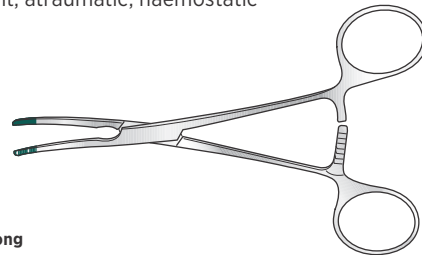

155mm long

Code	Description
Sb-GI/105	Curved
Sb-GI/106	Straight

### DeBakey Clamps

Box joint, atraumatic

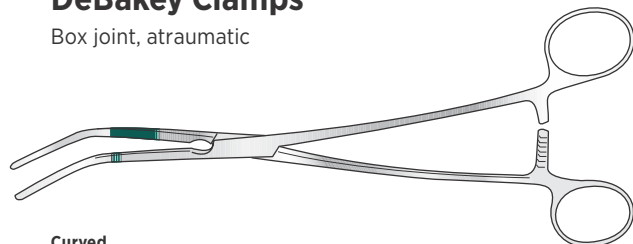

Curved

Code	Description
Sb-GI/086	230mm long

# ARTERY CLAMPS

STAHLÉAN BRAZIL  
SAVING LIVES



## DeBakey Clamps

Box joint, atraumatic

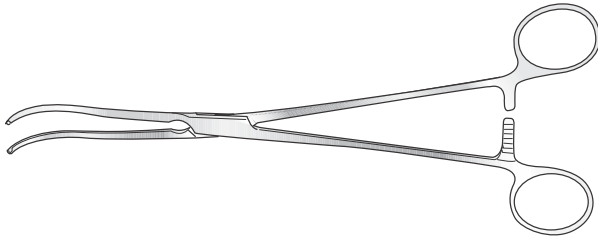

Curved

Code	Description
Sb-GI/088	230mm long
Sb-GI/089	240mm long
Sb-GI/090	245mm long

## DeBakey Clamps

Box joint, atraumatic

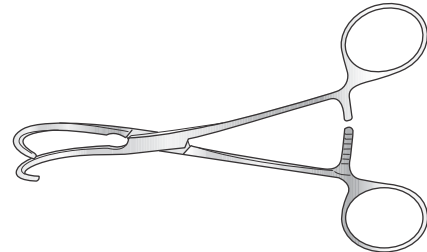

Curved

Code	Description
Sb-GI/094	150mm long

## DeBakey Clamps

Box joint, atraumatic

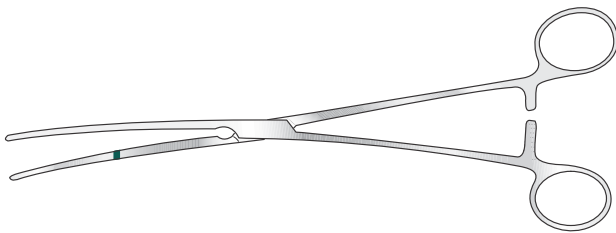

Curved

Code	Description
Sb-GI/091	250mm long
Sb-GI/092	270mm long
Sb-GI/093	280mm long

## DeBakey Clamps

Box joint, atraumatic

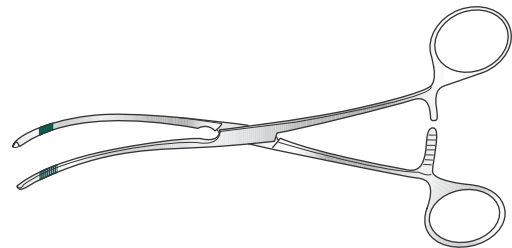

Curved

Code	Description
Sb-GI/096	180mm long
Sb-GI/097	203mm long

## DeBakey Clamps

Box joint, atraumatic, straight

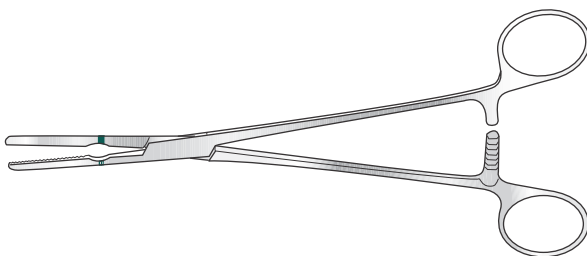

Curved

Code	Description
Sb-GI/100	160mm long
Sb-GI/104	165mm long
Sb-GI/101	203mm long
Sb-GI/098	215mm long
Sb-GI/102	220mm long
Sb-GI/103	230mm long
Sb-GI/099	245mm long

Box joint, atraumatic

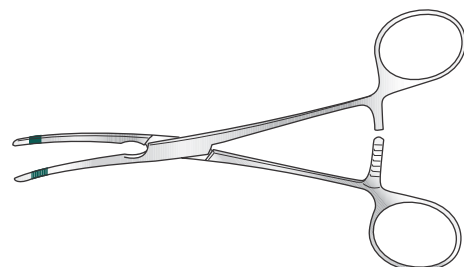

Curved

Code	Description
Sb-GI/080	165mm long
Sb-GI/081	190mm long
Sb-GI/082	203mm long
Sb-GI/083	215mm long
Sb-GI/084	220mm long

# CLAMPS

STAHLÉAN BRAZIL  
SAVING LIVES



## Duval Lung Grasping Clamps

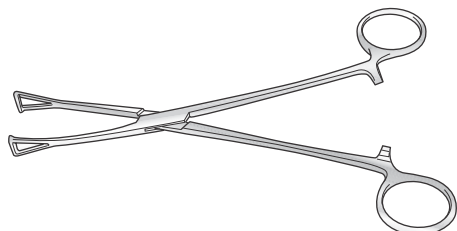

Code	Description
Sb-THO/033	185mm long

## Tudor Edwards Artery Clamps

Curved, serrated jaws, screw joint, satin finish

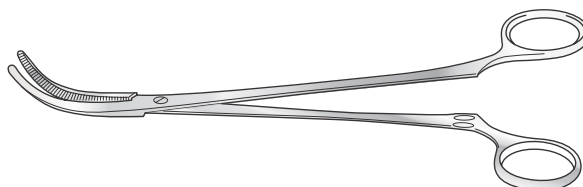

Code	Description
Sb-THO/015	230mm long

## Babcock Lung Grasping Clamps

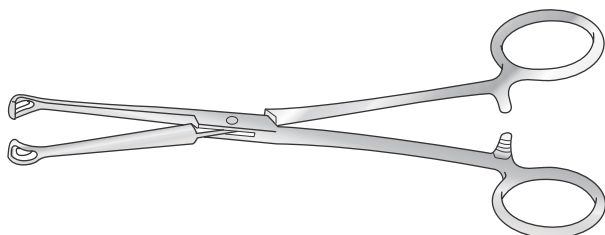

Code	Description
Sb-THO/034	245mm long

## O'Shaughnessy Artery Clamps

Right angled serrated jaw

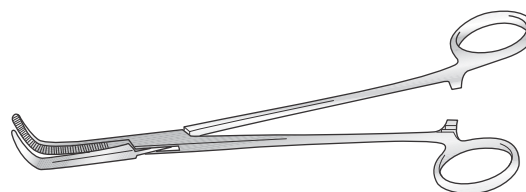

Code	Description
SbTHO/036a	150mm long
Sb-THO/036b	180mm long
Sb-THO/036c	200mm long
Sb-THO/036d	230mm long

Stahleanbrazil now  
offer a VATS range  
of instruments  
through Reuchlen



# CLAMPS

STAHLÉAN BRAZIL  
SAVING LIVES

## DeBakey Atraumatic Dissecting Clamps

Straight, atraumatic jaws

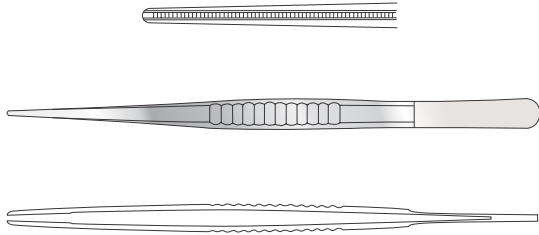

### 1.5mm

Code	Description
Sb-GI/238a	150mm long
Sb-GI/240a	240mm long

### 2.5mm

Code	Description
Sb-GI/238b	150mm long
Sb-GI/240b	240mm long

### 2mm

Code	Description
SI-GI/238	150mm long
SI-GI/241	180mm long

### 2.8mm

Code	Description
SI-GI/238c	150mm long
SI-GI/240c	240mm long
SI-GI/241c	180mm long

## Magill Intratracheal Catheter Clamps

Screw joint

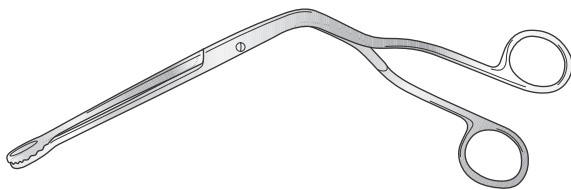

Code	Description
Sb-THO/032	Infant, 160mm long
Sb-THO/032a	Child, 190mm long
Sb-THO/032b	Adult, 230mm long

## SEMB Ligature Passing Clamps

240mm long

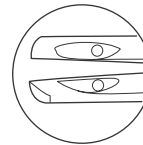
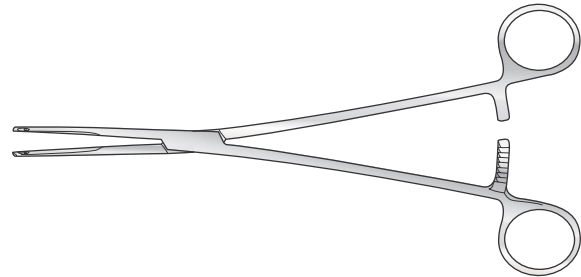

Code	Description
Sb-THO/044	Slightly curved
Sb-THO/045	Fully curved

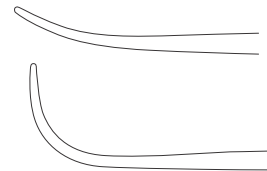

## Lambert-Kay Clamp

Atraumatic

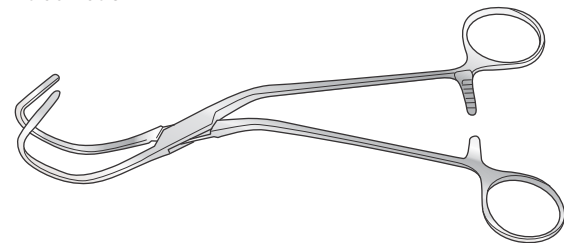

Code	Description
Sb-THO/029a	Curved, 220mm long
Sb-THO/029b	Straight, 215mm long
Sb-THO/029c	Straight, 200mm long

## Leland-Jones Clamp

Atraumatic, hemostatic

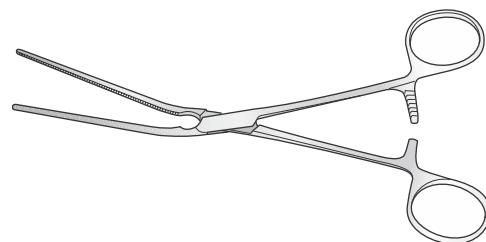

Code	Description
Sb-THO/023a	Curved, 190mm long
Sb-THO/023b	Straight, 195mm long

# CLAMPS

STAHLÉAN BRAZIL  
SAVING LIVES



## DeBakey Clamp

Straight jaws, ring handle

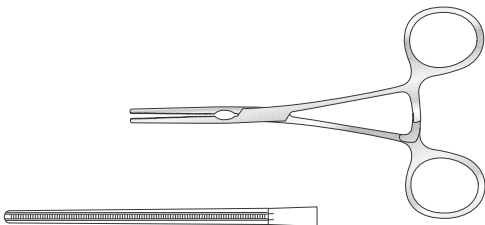

Code	Description
Sb-THO/048	137mm long

## DeBakey Clamp

'S' shaped curved jaws, curved shaft, ring handle

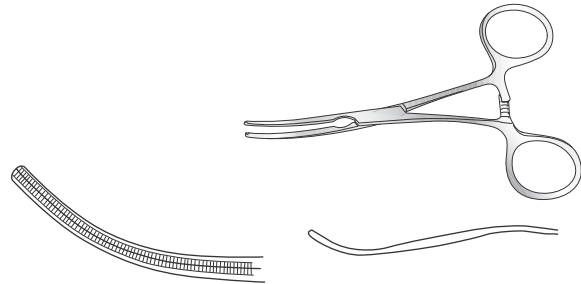

Code	Description
Sb-THO/049	127mm long

## DeBakey "S" Shaped Clamp

300mm long

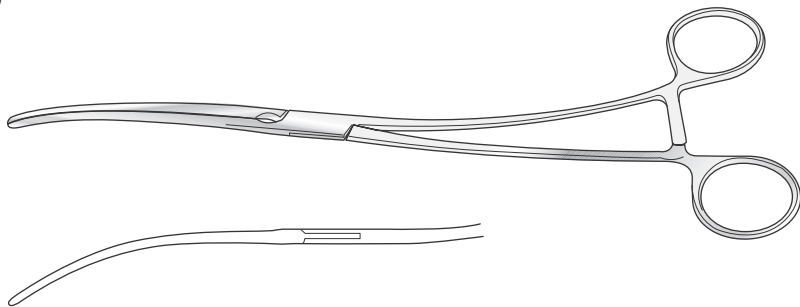

Code	Description
Sb-THO/096	115mm jaws

## DeBakey Atraumatic Clamp

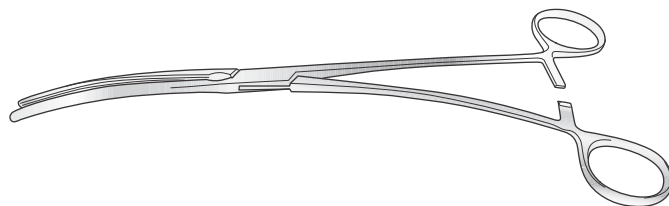

Code	Description
Sb-THO/090	110mm jaw, 300mm long
Sb-THO/092	95mm jaw, 250mm long

# CLAMPS

STAHLÉAN BRAZIL  
SAVING LIVES



## DeBakey Atraumatic Clamp

Right-angled, 40mm jaw

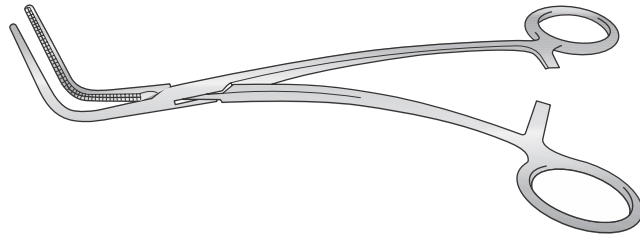

Code	Description
Sb-THO/044a	220mm long

## DeBakey Atraumatic Clamp

Right-angled, 50mm jaw

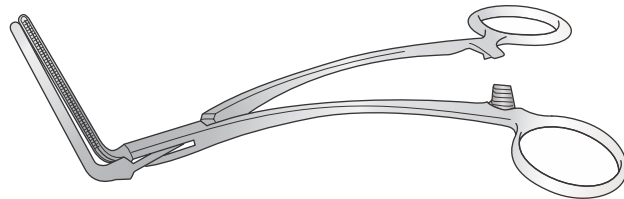

Code	Description
Sb-THO/045	200mm long

## DeBakey Atraumatic Clamp

Right-angled, 65mm jaw

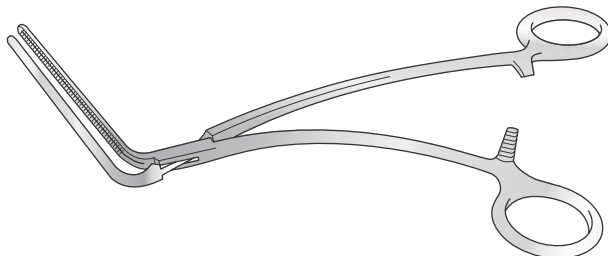

Code	Description
Sb-THO/046	215mm long

## DeBakey Atraumatic Clamp

Right-angled, 100mm jaw

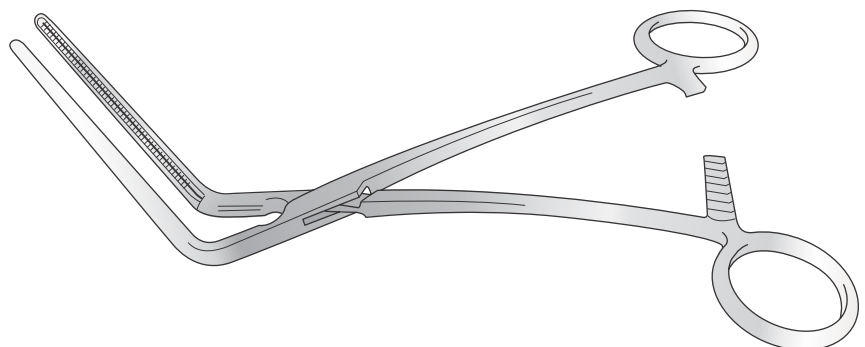

Code	Description
Sb-THO/047	280mm long

# CLAMPS

STAHLÉAN BRAZIL  
SAVING LIVES



## DeBakey Coarctation Clamp

Angled, 225mm long

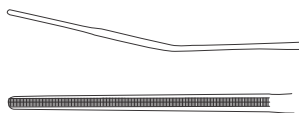

Code

Sb-THO/052

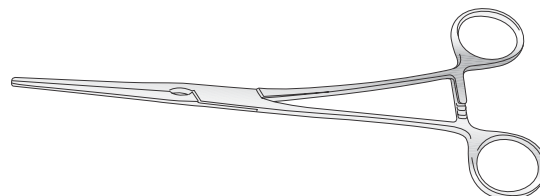

## DeBakey Multipurpose Clamp

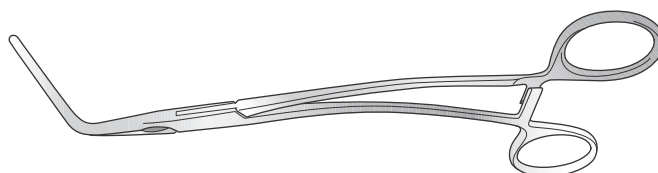

Code

Sb-THO/095

Description

85mm jaw, 230mm long

Sb-THO/064

100mm jaw, 280mm long

## DeBakey Multipurpose Clamp

Obtuse angled 60°, 280mm long

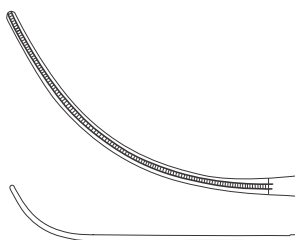

Code

Sb-THO/053

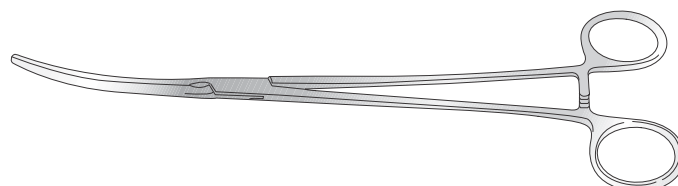

## DeBakey 45° Paediatric Clamp

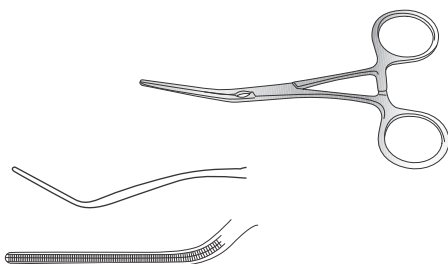

Code

Sb-THO/050

Description

130mm long

## DeBakey 90° Paediatric Clamp

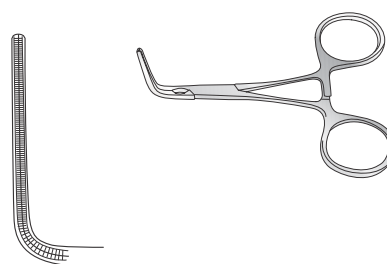

Code

Sb-THO/051

Description

105mm long

# BULLDOG CLAMPS

STAHLÉAN BRAZIL  
SAVING LIVES



## Dieffenbach Bulldog Clamp

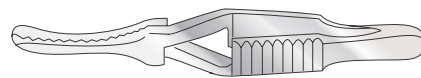
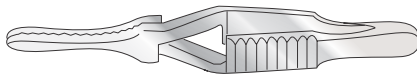

### Straight, serrated

Code	Description
Sb-GI/112	1.2mm fine jaw, 40mm long
Sb-GI/113	1.2mm fine jaw, 45mm long
Sb-GI/108	1.8mm jaw, 30mm long
Sb-GI/109	1.8mm jaw, 35mm long
Sb-GI/110	2.5mm jaw, 40mm long
Sb-GI/111	2.5mm jaw, 45mm long
Sb-GI/107	6mm heavy jaw, 60mm long
Sb-GI/455	20mm jaw, 75mm long
Sb-GI/455a	30mm jaw, 85mm long
Sb-GI/455b	45mm jaw, 105mm long
Sb-GI/455c	65mm jaw, 120mm long

### Straight, plain

Code	Description
Sb-GI/129	1.2mm fine jaw, 40mm long
Sb-GI/131	1.2mm fine jaw, 45mm long
Sb-GI/121	1.8mm jaw, 30mm long
Sb-GI/123	1.8mm jaw, 35mm long
Sb-GI/125	2.5mm jaw, 40mm long
Sb-GI/127	2.5mm jaw, 45mm long

### Curved, serrated

Code	Description
Sb-GI/119	1.2mm fine jaw, 40mm long
Sb-GI/120	1.2mm fine jaw, 45mm long
Sb-GI/115	1.8mm jaw, 30mm long
Sb-GI/116	1.8mm jaw, 35mm long
Sb-GI/117	2.5mm jaw, 40mm long
Sb-GI/118	2.5mm jaw, 45mm long
Sb-GI/114	6mm heavy jaw, 60mm long
Sb-GI/456	20mm jaw, 75mm long
Sb-GI/456a	30mm jaw, 85mm long
Sb-GI/456b	45mm jaw, 105mm long
Sb-GI/456c	65mm jaw, 120mm long

### Curved, plain

Code	Description
Sb-GI/130	1.2mm fine jaw, 40mm long
Sb-GI/132	1.2mm fine jaw, 45mm long
Sb-GI/122	1.8mm jaw, 30mm long
Sb-GI/124	1.8mm jaw, 35mm long
Sb-GI/126	2.5mm jaw, 40mm long
Sb-GI/128	2.5mm jaw, 45mm long

## Blalock Bulldog Clamp

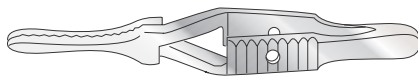

### Serrated, with hole in handle

#### Straight

Code	Description
Sb-GI/480	11mm jaw, 38mm long
Sb-GI/482	14mm jaw, 48mm long
Sb-GI/493	17mm jaw, 60mm long
Sb-GI/481	27mm jaw, 70mm long

#### Curved

Code	Description
Sb-GI/478	11mm jaw, 38mm long
Sb-GI/479	14mm jaw, 48mm long
Sb-GI/491	17mm jaw, 60mm long
Sb-GI/492	27mm jaw, 70mm long

## Diethrich Bulldog Clamp

Angled 12mm jaw

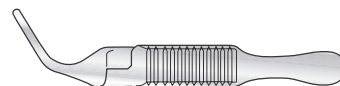

Code	Description
Sb-JD-GI/8097	44mm long

### Plain, with hole in handle

#### Straight

Code	Description
Sb-GI/486	11mm jaw, 38mm long
Sb-GI/487	14mm jaw, 48mm long
Sb-GI/488	17mm jaw, 60mm long
Sb-GI/489	27mm jaw, 70mm long

#### Curved

Code	Description
Sb-GI/483	11mm jaw, 38mm long
Sb-GI/484	14mm jaw, 48mm long
Sb-GI/485	17mm jaw, 60mm long
Sb-GI/490	27mm jaw, 70mm long

# SCISSORS

STAHLÉAN BRAZIL  
SAVING LIVES



## Potts Scissors

Satin finish, 190mm long

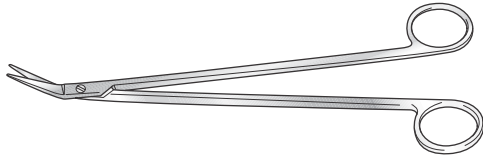

Code	Description
Sb-THO/019	Angled on flat 45°
Sb-THO/020a	Angled to side 45°
Sb-THO/020b	Acute angle to side

## Potts Diethrich Scissors

Supercut, 190mm long

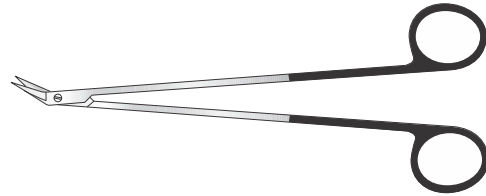

Code	Description
Sb-THO/078	25° angled on side
Sb-THO/079	45° angled on side
Sb-THO/080	90° angled on side

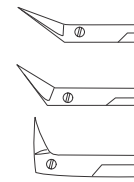

## Diethrich Circumflex Artery Scissors

Supercut, 175mm long

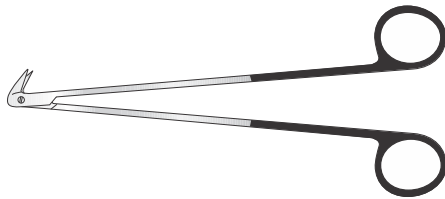

Code	Description
Sb-THO/077	125° angled on side

## Boyd Scissor

Supercut, slight curve

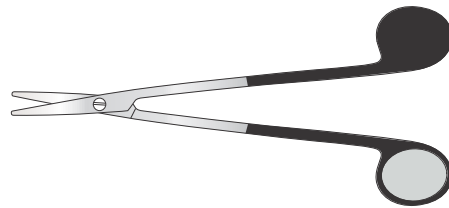

Code	Description
Sb-THO/047	180mm long

## Lobectomy Scissors

Curved on flat

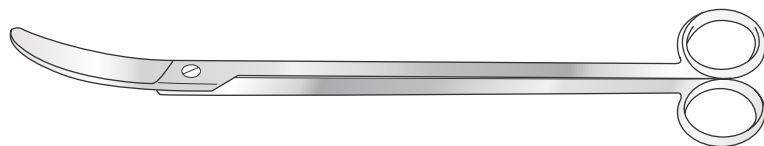

Code	Description
Sb-THO/001b	305mm long

## Nelson Lobectomy Scissor

Tungsten carbide, curved on flat, 230mm long

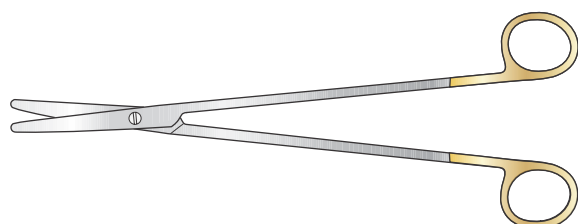

Code
Sb-THO/057

# NEEDLE HOLDERS



## Needle Holder and Wire Twister

For sternum wire, left-handed, 300mm long

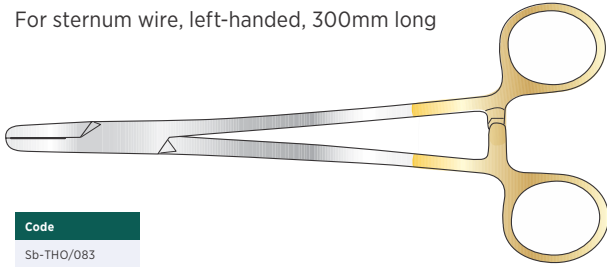

### Code

Sb-THO/083

## Julian Needle Holder

Light, delicate model, with tungsten carbide jaws  
220mm long

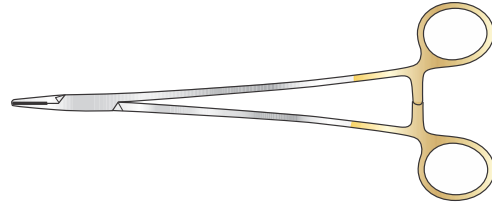

### Code

Sb-THO/081

Sb-THO/081a

### Description

Left-handed

## Rochester Needle Holder

Light, delicate model, with tungsten carbide jaws  
190mm long

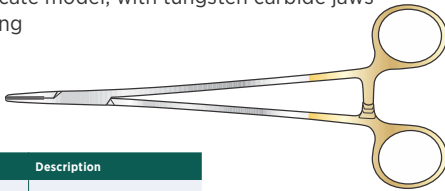

### Code

Sb-THO/082

Sb-THO/082a

### Description

Left-handed

## DeBakey Needle Holder

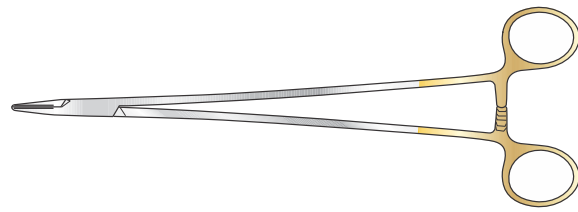

## Stratte Needle Holder

210mm long

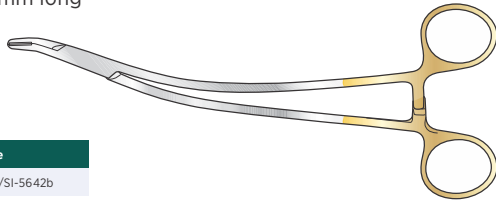

### Code

THO/SI-5642b

### Code

THO/SI-5642a

Sb-GI/502A

Sb-GI/502

SI003944

Sb-5642A

Sb-GI/036BM

Sb-GI/037BM

Sb-GI/038BM

### Description

250mm long

165mm very delicate

180mm tungsten carbide

260mm long straight with tungsten carbide inserts

240mm long

Tungsten carbide delicate 230mm long

Tungsten carbide delicate 250mm long

Tungsten carbide delicate 305mm long

## Castroviejo Needle Holder

### Code

Sb-OP/021

Sb-OP/020

### Description

140mm long, with catch

140mm long, without catch

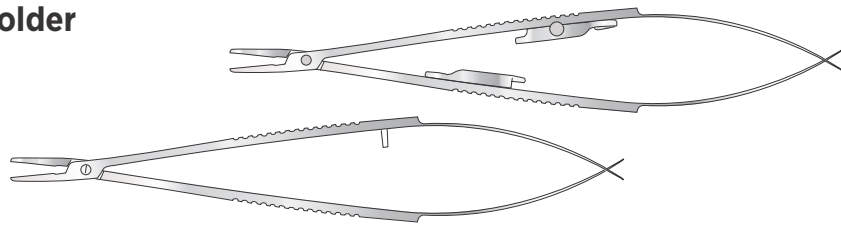

## Diamond dust jaws

### Code

Sb-THO/060

Sb-THO/061

Sb-THO/062

### Description

180mm long, without catch

200mm long, without catch

215mm long, without catch



ALSO AVAILABLE WITH CATCH - ADD SUFFIX CTH TO CODE

## Tungsten carbide jaws

### Code

Sb-THO/058a

Sb-THO/058

Sb-THO/059

### Description

180mm long

200mm long

215mm long

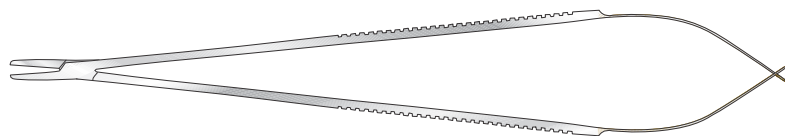

ALSO AVAILABLE WITH CATCH - ADD SUFFIX CTH TO CODE

# RETRACTORS

STAHLÉAN BRAZIL  
SAVING LIVES



## Blanco Valve Leaflet Retractor

280mm long



### Code

Sb-THO/041

## Harrington Splanchnic Retractor

Small size, end of blade  
38mm wide x 127mm deep  
satin finish handle

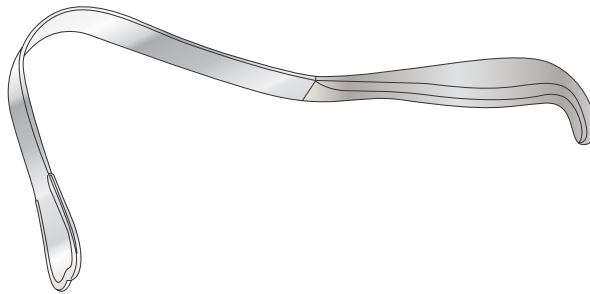

### Code Description

Sb-THO/011 320mm long

## Brocks Erecton Spinal Back End Retractor

215mm long

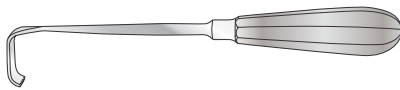

### Code Description

Sb-THO/054 13 x 28mm

## Cleland Valve Leaflet Retractor

250mm long



### Code

Sb-THO/097

## Ross Retractor

250mm long



### Code Description

Sb-THO/089 16mm x 15mm blade

Sb-THO/089a 23mm x 13mm blade

Sb-THO/089b 24mm x 16mm blade

### Code Description

Sb-THO/089c 27mm x 13mm blade

Sb-THO/089d 27mm x 27mm blade

Sb-THO/089e 25mm x 38mm blade

## Tudor Edwards Retractor

25mm Wide

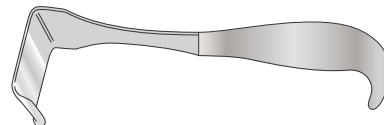

### Code Description

Sb-THO/013 205mm long

## Allison Lung Retractor

Satin finish handle

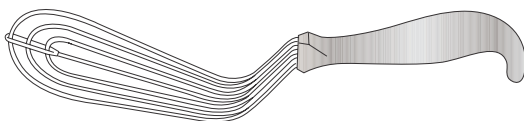

### Code Description

Sb-THO/012a Infant

Sb-THO/012b Child, 280mm blade

Sb-THO/012c Adult, 300mm blade

## Cooley Atrial Retractor

260mm overall length

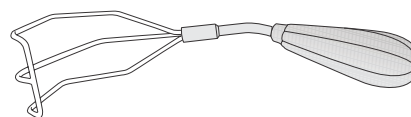

### Code Description

Sb-THO/046 Right

Sb-THO/046a Left

# RIB SPREADERS

STAHLÉAN BRAZIL  
SAVING LIVES



## Finochietto Rib Spreader

Straight arms, 20mm square blades

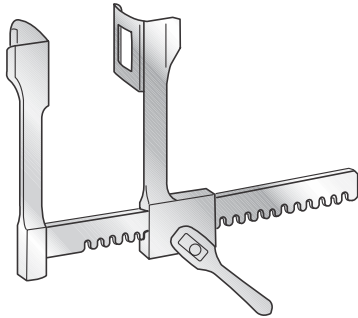

Code	Description
Sb-THO/006	Infant, maximum opening 80mm x 60mm long
Sb-THO/037	Adult, maximum opening 200mm, blades 44 x 65mm

## Morse-Favaloro Rib Spreader

Curved arms, 275mm long

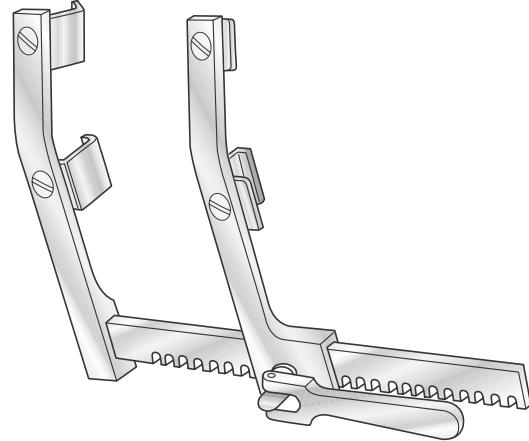

Code	Description
Sb-THO/103	Swivel blades 215mm long
Sb-THO/103a	Swivel blades 185mm long

## IMA Rib Spreader

Converts left or right

Code	Description
Sb-THO/102	Standard frame only
Sb-THO/102a	Ministernotomy frame only
Sb-THO/102b	Complete, standard, 1 x frame, 1 x 100mm long x 20mm wide U shaped blade, 1 x claw blades 28mm and 32mm deep
Sb-THO/102c	Complete, ministernotomy, 1 x frame, 1 x 30mm long x 20mm wide U shaped blade, 1 x claw blades 43mm and 50mm deep

### Claw blade only

Code	Description
Sb-THO/102d	28mm deep
SbTHO/102e	32mm deep
SbTHO/102f	38mm deep
Sb-THO/102g	43mm deep
SbTHO/102h	50mm deep

### U shaped blade only

Code	Description
SbTHO/102i	100mm long x 20mm wide
SbTHO/102j	100mm long x 25mm wide
SbTHO/102k	30mm long x 20mm wide

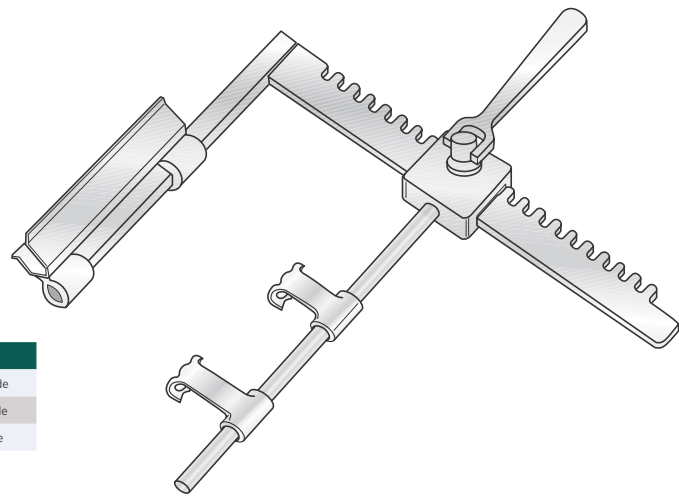

## Price Thomas Rib Spreader

Code	Description
Sb-THO/99	Complete with 3 pairs of blades, key, 250, 215, 68mm
Sb-THO/99a	Blade only, 50mm x 38mm, pair
Sb-THO/99b	Blade only, 50mm x 45mm, pair
Sb-THO/99c	Blade only, 50mm x 65mm, pair
Sb-THO/99d	Nut and bolt for blade only
SbTHO/99e	Frame only
Sb-THO/99f	Key only

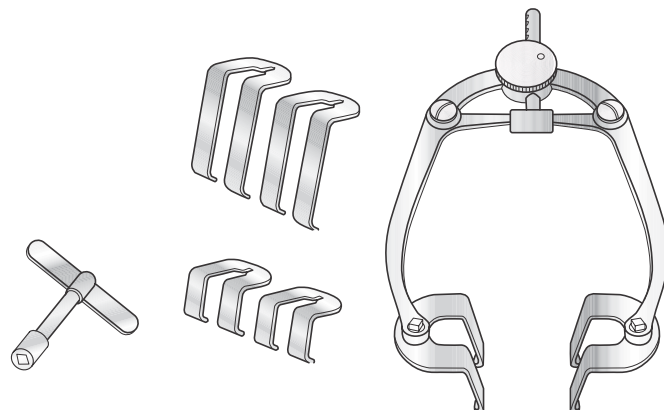

# RIB SPREADERS

STAHLÉAN BRAZIL  
SAVING LIVES



## Sellers Rib Spreader

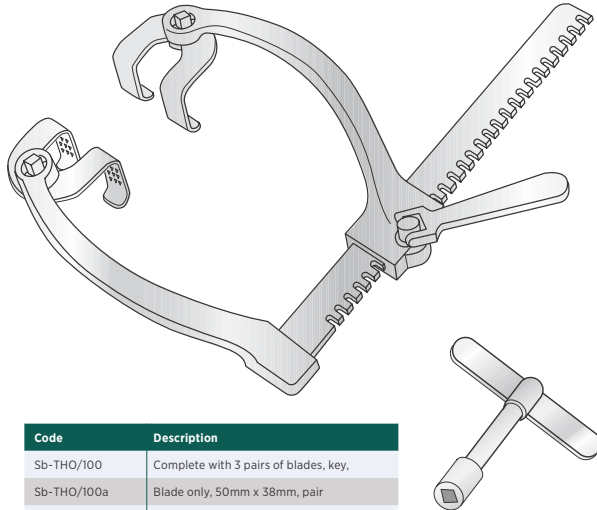

Code	Description
Sb-THO/100	Complete with 3 pairs of blades, key,
Sb-THO/100a	Blade only, 50mm x 38mm, pair
Sb-THO/100b	Blade only, 50mm x 45mm, pair
Sb-THO/100c	Blade only, 50mm x 65mm, pair
Sb-THO/100d	Frame only
Sb-THO/100e	Nut and bolt for blade only
Sb-THO/100f	Key only

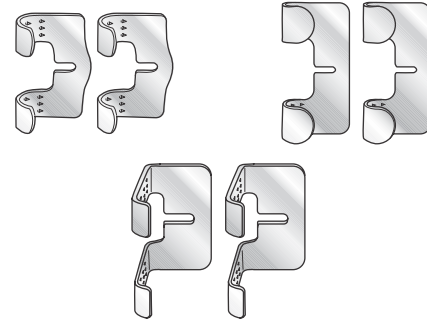

### Harefield sternal blade only, pair

Code	Description
Sb-THO/100g	70 x 30mm
Sb-THO/100h	120 x 30mm

### Harefield scapula blade only, pair

Code	Description
Sb-THO/100i	75 x 70mm

## Ronald Edwards Rib Spreader

Curved arms, fenestrated

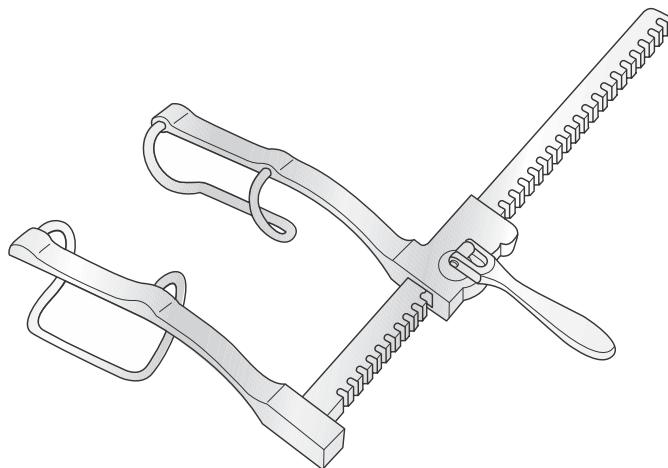

Code	Description
Sb-THO/104	Infant, 100mm, 25mm x 30mm blades
SbSH-5158	Child, 150mm, 30mm x 50mm blades
Sb-SH-5720	Adult, 245mm, 65mm x 75mm blades

## Bailey Rib Approximator and Spreader

Combined, satin finish

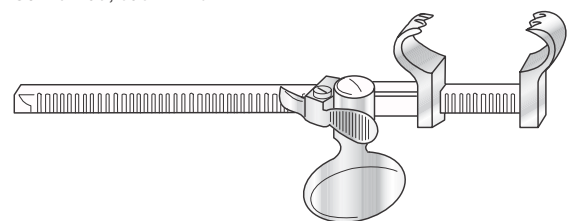

Code	Description
Sb-THO/003	160mm long

## Sellers Rib Approximator and Spreader

Combined action, satin finish

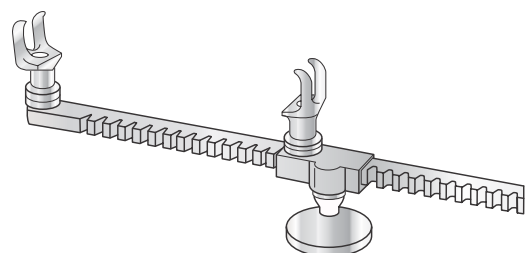

Code	Description
Sb-THO/002	195mm long

# RIB SPREADERS

STAHLÉAN BRAZIL  
SAVING LIVES



## Cooley Rib Spreader

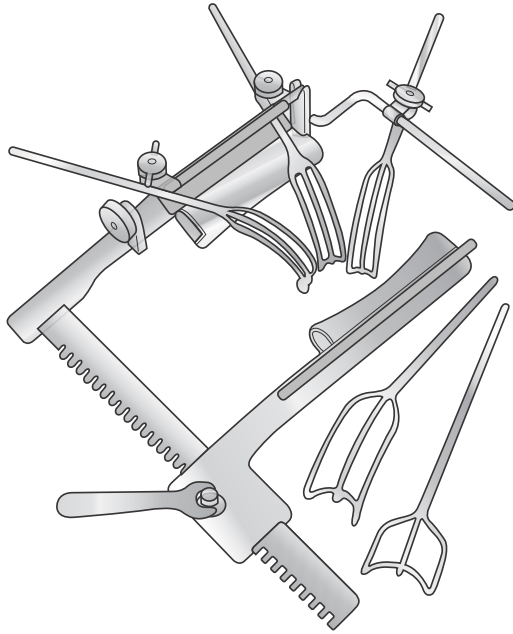

Code	Description
Sb-43950-50	Adult, 40mm x 110mm blades, complete with cosgrove mounting bars
Sb-43950-90	Adult, 40mm x 110mm blades, complete with cosgrove mitral valve retractor attachment, 5 x blades, 3 x clamp, 1 x side arm

## Wells Rib Spreader

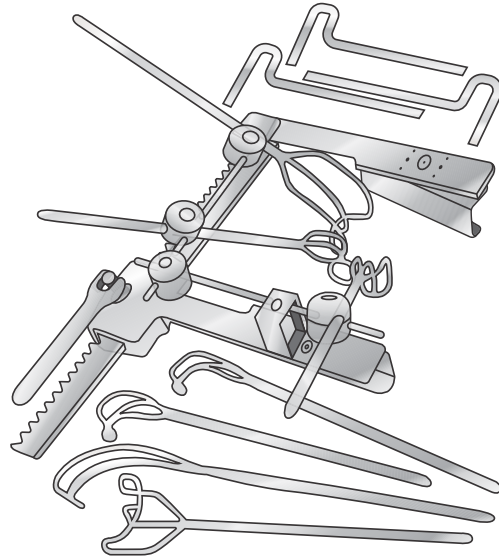

Code	Description
Sb-44080-65	Small rake retractor on shaft
Sb-44080-80	Frame only, 90mm wide x 25mm deep blades
Sb-44080-90	Complete, frame, pillar clamp, 4 x ball clamps, 2 x mounting bars, hex keys, 1 x tricuspid rake ret, 2 x small, medium and large rake ret

## Tudor Edwards Rib Spreader

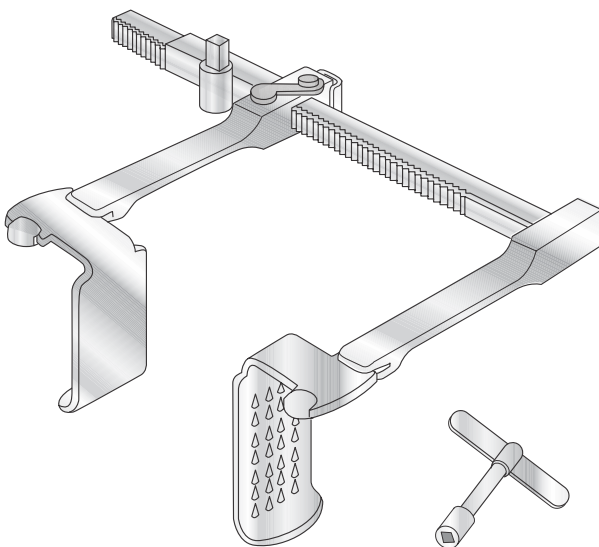

Code	Description
Sb-THO/101	Complete, 2 of each blade, plus key
Sb-THO/101a	25mm blade only, pair
Sb-THO/101b	50mm blade only, pair
Sb-THO/101c	75mm blade only, pair

## Tufer Rib Spreader

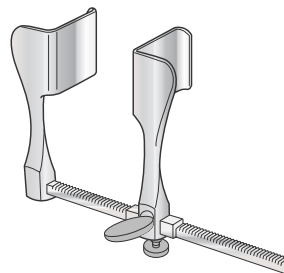

Code	Description
Sb-THO/005	Blades 25mm deep x 19mm wide

Satin finish handles

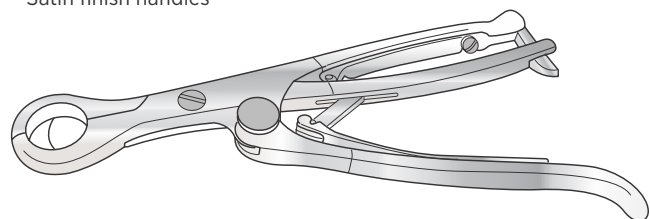

Code	Description
Sb-THO/010	240mm long

# RIB SHEARS AND LUNG FORCEPS

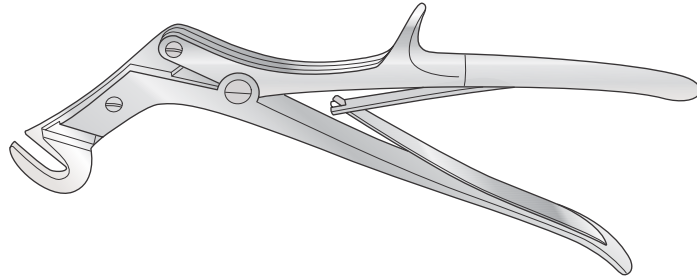

Code	Description
Sb-THO/041	270mm long

## Tudor Edwards Rib Shears

Compound action, anterior

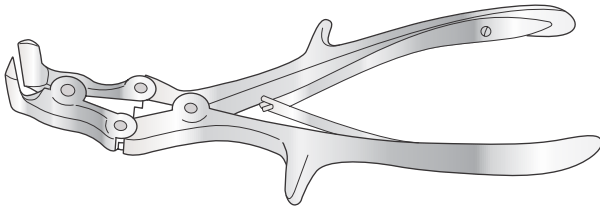

Code	Description
Sb-THO/042	235mm long

## Mayo Lung Forceps

Fenestrated, semi-circular jaw, satin finish

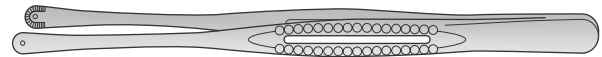

Code	Description
Sb-THO/014	230mm long

## Special Care Needed For Your Thoracic Instruments

### Staining



Beware of the use of Saline during surgery. This can be very damaging to any instrument if not immediately rinsed after surgery. Saline is highly corrosive. The image shows damage to the passive surface of an instrument.

### Rusting



Due to the nature of their use, Thoracic Retractors can tarnish or present rust easily. These retractors can be fully refurbished and passivated by stahleanbrazil

# ELEVATORS AND MISCELLANEOUS

## Tudor Edwards Periosteal Elevator

First rib, 175mm long

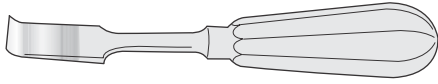

Code	Description
Sb-THO/009b	18mm wide

## Doyen Periosteal Elevator

Satin finish handle

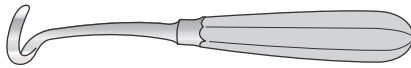

165mm long

Code	Description
Sb-OR/N031	Right
Sb-OR/N032	Left

180mm long

Code	Description
SbOR/256	Right
SbOR/255	Left

## Blalock Hook

249mm long



Code	Description
Sb-THO/042	45° angle, 5mm tip
SbTHO/043b	90° angle, 5mm tip

## Ross (Papworth) Ventricular Sucker

33mm long

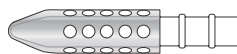

Code	Description
SbTHO/PAP001	Bullet

## Ross (Papworth) Sump Sucker

42mm long

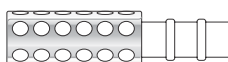

Code	Description
Sb-THO/PAP002	Round end

## Ross (Papworth) Flat Sucker

42mm long

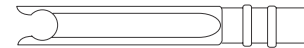

Code

SI-THO/PAP003

## Ross Probe

200mm long

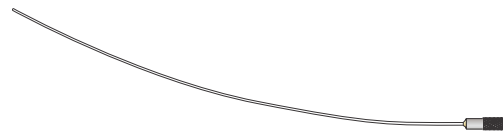

Code

Sb-THO/055

1mm

Sb-THO/055a

1.5mm

## Tibbs Arterial Cannula

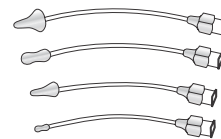

GU pattern

Code	Description
Sb-TIB/001	Set of four
Sb-TIB/002	Large cone
SbTIB/003	Large olive
SbTIB/004	Small cone
SbTIB/005	Small olive

Code	Description
SbTIB/006	Large cone
Sb-TIB/007	Large olive
Sb-TIB/008	Small cone
Sb-TIB/009	Small olive
Sb-TIB/010	Set of four



# STAHLÉAN BRAZIL

SAVING LIVES

## CONTACT US

Office in são paulo

 +5511972111007

 +5511933211007

 +923347711007

 @stahleanbrazil

 info@stahleanbrazil.com

 www.stahleanbrazil.com