

STAHLÉAN BRAZIL
SAVING LIVES



General Instruments



www.stahleanbrazil.com

General Instruments

| | |
|--|----|
| Artery Forceps | 3 |
| Clamps | 6 |
| Spring Forceps | 7 |
| Tissue Forceps | 9 |
| Sponge Holding and Sterilising Forceps | 11 |
| Other Forceps | 12 |
| Scissors | 13 |
| Needle Holders | 14 |
| Combined Scissor and Needle Holders | 15 |
| Bag and Towel Clips | 17 |
| Retractors | 18 |
| Dissectors and Probes | 20 |
| Miscellaneous | 22 |
| Hollow Ware | 23 |
| Silicone Matting | 24 |
| Sterilising Baskets | 25 |
| Optical Fibre Cables | 26 |

ARTERY FORCEPS

STAHLÉAN BRAZIL
SAVING LIVES



Adson Artery Forceps

Box joint, 180mm long

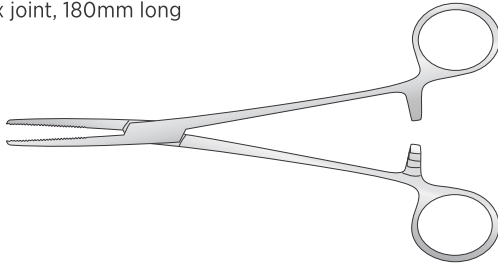

Serrated jaws

| Code | Description |
|------------|-------------|
| Sb-GI/034 | Straight |
| Sb-GI/034a | Curved |

1-2 teeth

| Code | Description |
|------------|-------------|
| Sb-GI/034b | Straight |
| Sb-GI/034c | Curved |

Cushing Artery Forceps

Box joint, fine, half serrated jaws, 140mm long

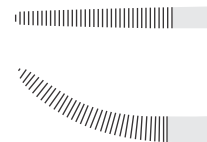
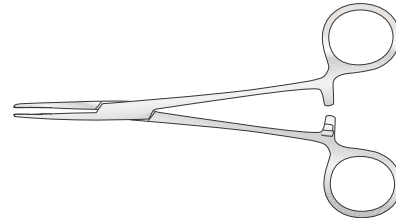

| Code | Description |
|-----------|-------------|
| Sb-GI/001 | Straight |
| Sb-GI/002 | Curved |

Cairns Artery Forceps

Box joint, half serrated jaws
145mm long

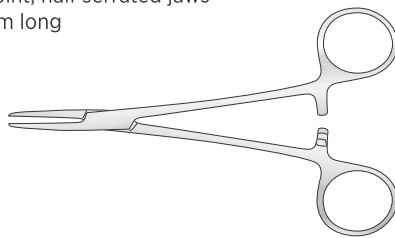

Serrated jaws

| Code | Description |
|-----------|-------------|
| Sb-GI/415 | Straight |

1-2 teeth

| Code | Description |
|-----------|----------------|
| Sb-GI/020 | Curved |
| Sb-GI/021 | Curved to side |

Dunhill Artery Forceps

Box joint, fine serrations

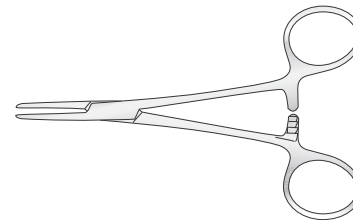

Straight

| Code | Description |
|------------|-------------|
| Sb-GI/065 | 135mm long |
| Sb-GI/065a | 190mm long |

Curved

| Code | Description |
|-----------|-------------|
| Sb-GI/043 | 135mm long |
| Sb-GI/468 | 180mm long |

Crile Artery Forceps

Box joint, serrated jaws

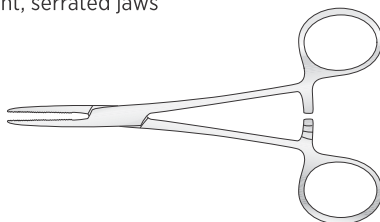

Straight

| Code | Description |
|------------|-------------|
| Sb-GI/014 | 140mm long |
| Sb-GI/014a | 160mm long |

Curved

| Code | Description |
|------------|-------------|
| Sb-GI/015 | 140mm long |
| Sb-GI/015a | 160mm long |

Lawson Tait Artery Forcep

Box joint, straight jaw

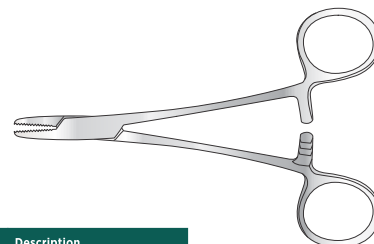

| Code | Description |
|--------------|-------------|
| Sb-GI/SH5924 | 140mm long |

ARTERY FORCEPS

STAHLÉAN BRAZIL
SAVING LIVES



Adson Artery Forceps

Box joint, 180mm long

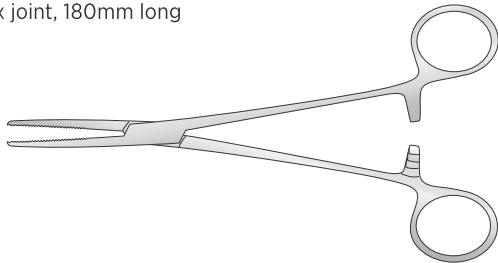

Serrated jaws

| Code | Description |
|------------|-------------|
| Sb-GI/034 | Straight |
| Sb-GI/034a | Curved |

1-2 teeth

| Code | Description |
|------------|-------------|
| Sb-GI/034b | Straight |
| Sb-GI/034c | Curved |

Cushing Artery Forceps

Box joint, fine, half serrated jaws, 140mm long

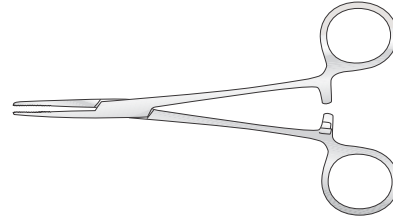

| Code | Description |
|-----------|-------------|
| Sb-GI/001 | Straight |
| Sb-GI/002 | Curved |

Cairns Artery Forceps

Box joint, half serrated jaws
145mm long

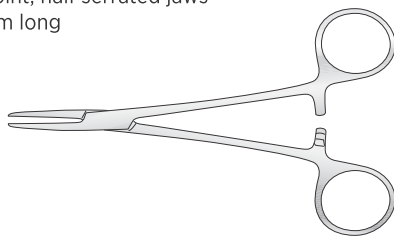

Serrated jaws

| Code | Description |
|-----------|-------------|
| Sb-GI/415 | Straight |

1-2 teeth

| Code | Description |
|-----------|----------------|
| Sb-GI/020 | Curved |
| Sb-GI/021 | Curved to side |

Dunhill Artery Forceps

Box joint, fine serrations

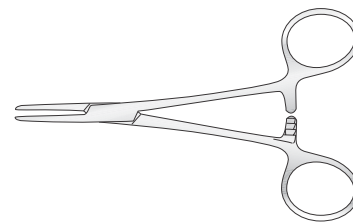

Straight

| Code | Description |
|------------|-------------|
| Sb-GI/065 | 135mm long |
| Sb-GI/065a | 190mm long |

Curved

| Code | Description |
|-----------|-------------|
| Sb-GI/043 | 135mm long |
| Sb-GI/468 | 180mm long |

Crile Artery Forceps

Box joint, serrated jaws

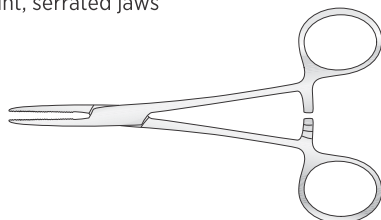

Straight

| Code | Description |
|------------|-------------|
| Sb-GI/014 | 140mm long |
| Sb-GI/014a | 160mm long |

Curved

| Code | Description |
|------------|-------------|
| Sb-GI/015 | 140mm long |
| Sb-GI/015a | 160mm long |

Lawson Tait Artery Forcep

Box joint, straight jaw

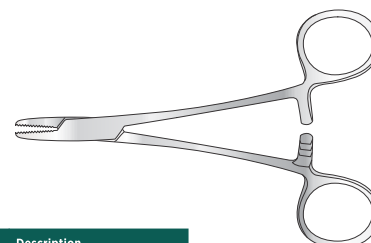

| Code | Description |
|--------------|-------------|
| Sb-GI/SH5924 | 140mm long |

ARTERY FORCEPS

STAHLÉAN BRAZIL

SAVING LIVES



Halstead Mosquito Forceps

Standard pattern, haemostatic, box joint

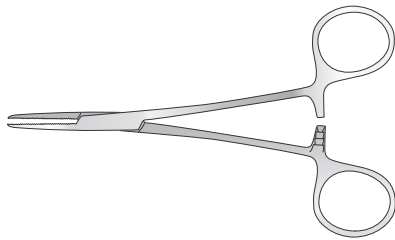

Serrated jaw

| Code | Description |
|-----------|-------------------------|
| Sb-GI/007 | Straight 125mm long |
| Sb-GI/008 | Curved 125mm long |
| Sb-GI/009 | Fully curved 125mm long |

1-2 teeth

| Code | Description |
|-----------|---------------------|
| Sb-GI/010 | Straight 125mm long |
| Sb-GI/012 | Straight 190mm long |
| Sb-GI/011 | Curved 125mm long |
| Sb-GI/013 | Curved 190mm long |

Micro, 100mm long

| Code | Description |
|-----------|---------------------|
| Sb-GI/003 | Straight, serrated |
| Sb-GI/004 | Curved, serrated |
| Sb-GI/005 | Straight, 1-2 teeth |
| Sb-GI/006 | Curved, 1-2 teeth |

Heiss Artery Forceps

Box joint, 205mm long

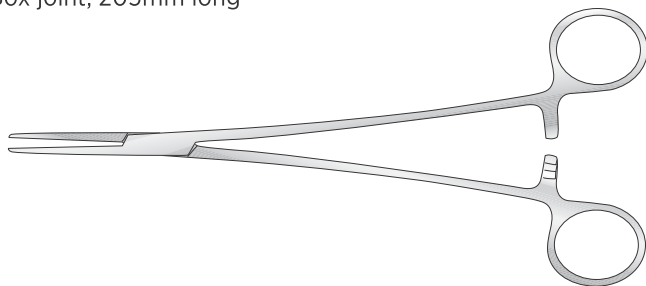

Serrated jaws

| Code | Description |
|-----------|-------------|
| Sb-GI/016 | Straight |
| Sb-GI/017 | Curved |

1-2 teeth

| Code | Description |
|------------|-------------|
| Sb-GI/016a | Straight |
| Sb-GI/017b | Curved |

Kelly Artery Forceps

Box joint, half serrated jaws



Straight

| Code | Description |
|-----------|-------------|
| Sb-GI/022 | 140mm long |
| Sb-GI/023 | 160mm long |

Curved

| Code | Description |
|-----------|-------------|
| Sb-GI/024 | 140mm long |
| Sb-GI/025 | 160mm long |

Fraser Kelly Artery Forceps Curved

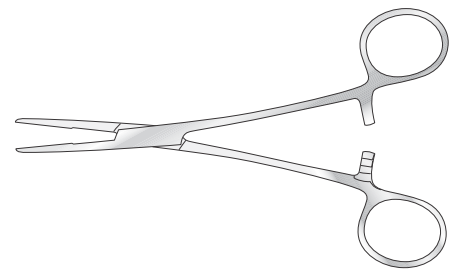

Straight

| Code | Description |
|------------|-------------|
| Sb-GI/468a | 180mm |

Kocher Artery Forceps

Box joint, 1-2 teeth

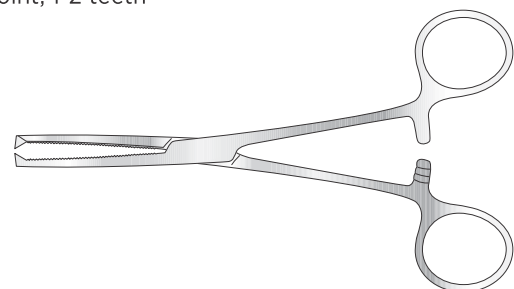

Straight

| Code | Description |
|-----------|-------------|
| Sb-GI/052 | 130mm long |
| Sb-GI/053 | 150mm long |
| Sb-GI/054 | 180mm long |
| Sb-GI/055 | 200mm long |
| Sb-GI/056 | 230mm long |

Curved

| Code | Description |
|-----------|-------------|
| Sb-GI/057 | 150mm long |
| Sb-GI/058 | 180mm long |
| Sb-GI/059 | 200mm long |
| Sb-GI/060 | 230mm long |

CLAMPS



Dieffenbach Bulldog Clamp

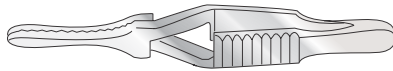

Straight, serrated

| Code | Description |
|------------|---------------------------|
| Sb-GI/112 | 1.2mm fine jaw, 40mm long |
| Sb-GI/113 | 1.2mm fine jaw, 45mm long |
| Sb-GI/108 | 1.8mm jaw, 30mm long |
| Sb-GI/109 | 1.8mm jaw, 35mm long |
| Sb-GI/110 | 2.5mm jaw, 40mm long |
| Sb-GI/111 | 2.5mm jaw, 45mm long |
| Sb-GI/107 | 6mm heavy jaw, 60mm long |
| Sb-GI/455 | 20mm jaw, 75mm long |
| Sb-GI/455a | 30mm jaw, 85mm long |
| Sb-GI/455b | 45mm jaw, 105mm long |
| Sb-GI/455c | 65mm jaw, 120mm long |

Straight, plain

| Code | Description |
|-----------|---------------------------|
| Sb-GI/129 | 1.2mm fine jaw, 40mm long |
| Sb-GI/131 | 1.2mm fine jaw, 45mm long |
| Sb-GI/121 | 1.8mm jaw, 30mm long |
| Sb-GI/123 | 1.8mm jaw, 35mm long |
| Sb-GI/125 | 2.5mm jaw, 40mm long |
| Sb-GI/127 | 2.5mm jaw, 45mm long |

Curved, serrated

| Code | Description |
|------------|---------------------------|
| Sb-GI/119 | 1.2mm fine jaw, 40mm long |
| Sb-GI/120 | 1.2mm fine jaw, 45mm long |
| Sb-GI/115 | 1.8mm jaw, 30mm long |
| Sb-GI/116 | 1.8mm jaw, 35mm long |
| Sb-GI/117 | 2.5mm jaw, 40mm long |
| Sb-GI/118 | 2.5mm jaw, 45mm long |
| Sb-GI/114 | 6mm heavy jaw, 60mm long |
| Sb-GI/456 | 20mm jaw, 75mm long |
| Sb-GI/456a | 30mm jaw, 85mm long |
| Sb-GI/456b | 45mm jaw, 105mm long |
| Sb-GI/456c | 65mm jaw, 120mm long |

Curved, plain

| Code | Description |
|-----------|---------------------------|
| Sb-GI/130 | 1.2mm fine jaw, 40mm long |
| Sb-GI/132 | 1.2mm fine jaw, 45mm long |
| Sb-GI/122 | 1.8mm jaw, 30mm long |
| Sb-GI/124 | 1.8mm jaw, 35mm long |
| Sb-GI/126 | 2.5mm jaw, 40mm long |
| Sb-GI/128 | 2.5mm jaw, 45mm long |

Blalock Bulldog Clamp



Serrated, with hole in handle

Straight

| Code | Description |
|-----------|---------------------|
| Sb-GI/480 | 11mm jaw, 38mm long |
| Sb-GI/482 | 14mm jaw, 48mm long |
| Sb-GI/493 | 17mm jaw, 60mm long |
| Sb-GI/481 | 27mm jaw, 70mm long |

Curved

| Code | Description |
|-----------|---------------------|
| Sb-GI/478 | 11mm jaw, 38mm long |
| Sb-GI/479 | 14mm jaw, 48mm long |
| Sb-GI/491 | 17mm jaw, 60mm long |
| Sb-GI/492 | 27mm jaw, 70mm long |

Plain, with hole in handle

Straight

| Code | Description |
|-----------|---------------------|
| Sb-GI/486 | 11mm jaw, 38mm long |
| Sb-GI/487 | 14mm jaw, 48mm long |
| Sb-GI/488 | 17mm jaw, 60mm long |
| Sb-GI/489 | 27mm jaw, 70mm long |

Curved

| Code | Description |
|-----------|---------------------|
| Sb-GI/483 | 11mm jaw, 38mm long |
| Sb-GI/484 | 14mm jaw, 48mm long |
| Sb-GI/485 | 17mm jaw, 60mm long |
| Sb-GI/490 | 27mm jaw, 70mm long |

An Overview On Forcep Jaw Types

You will see that forceps in our catalogue will have either a traditional serrated jaw or a different design which is known as atraumatic (or non-traumatic).

Traditional Serrated Jaw



The traditional serrated jaw is generally more robust and used on forceps where the areas are not as delicate.

Atraumatic Jaw



Atraumatic jaws will be mainly found in delicate surgery areas such as vascular and cardiothoracic. The design is such, that the surface area gripped is reduced, ensuring less trauma without the loss of grip.

SPRING FORCEPS

Adsons Dissecting Forceps

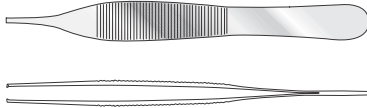

127mm long

| Code | Description |
|-----------|------------------------------|
| Sb-GI/257 | 1-2 teeth |
| Sb-GI/258 | Lightweight, micro |
| Sb-GI/259 | Serrated |
| Sb-GI/260 | Serrated, lightweight, micro |

Block End Dissecting Forceps

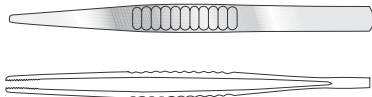

Serrated

| Code | Description |
|------------|-------------|
| Sb-GI/255 | 127mm long |
| Sb-GI/256 | 152mm long |
| Sb-GI/256a | 203mm long |

Bonney Dissecting Forceps

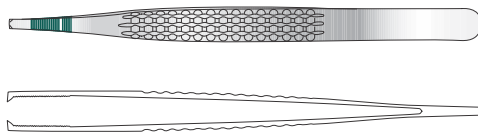

178mm long

| Code | Description |
|-----------|---------------------|
| Sb-GI/267 | Serrated, 1-2 teeth |
| Sb-GI/268 | 1-2 teeth |

Charnley-McIndoe Dissecting Forceps

150mm long

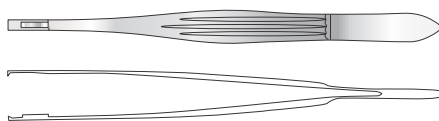

| Code | Description |
|-------------|-------------|
| Sb-OR/N045a | 2-3 teeth |

DeBakey Atraumatic Dissecting Forceps

Straight, atraumatic jaws

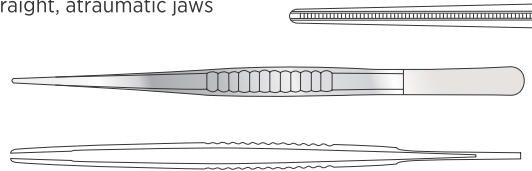

1.5mm

| Code | Description |
|------------|-------------|
| Sb-GI/238a | 150mm long |
| Sb-GI/240a | 240mm long |

2.5mm

| Code | Description |
|------------|-------------|
| Sb-GI/238b | 150mm long |
| Sb-GI/240b | 240mm long |

2mm

| Code | Description |
|-----------|-------------|
| Sb-GI/238 | 150mm long |
| Sb-GI/241 | 180mm long |

2.8mm

| Code | Description |
|------------|-------------|
| Sb-GI/238c | 150mm long |
| Sb-GI/240c | 240mm long |
| Sb-GI/241c | 180mm long |

Dissecting Forceps

Turnover end, serrated jaws

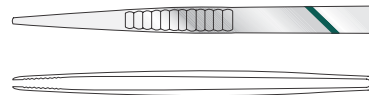

| Code | Description |
|-----------|-------------|
| Sb-GI/242 | 127mm long |
| Sb-GI/243 | 152mm long |

| Code | Description |
|-----------|-------------|
| Sb-GI/244 | 178mm long |
| Sb-GI/245 | 203mm long |

Dunhill Dissecting Forceps

Light, fine serrated jaws



| Code | Description |
|-----------|-------------|
| Sb-GI/457 | 145mm long |

Fredrick Coole Dissecting Forceps

Extra fine serrated jaws

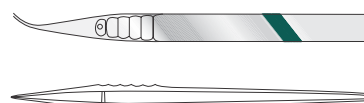

125mm long

| Code | Description |
|-----------|-------------|
| Sb-GI/066 | Straight |
| Sb-GI/067 | Curved |

SPRING FORCEPS

STAHLÉAN BRAZIL
SAVING LIVES



Gillies Dissecting Forceps

1-2 teeth

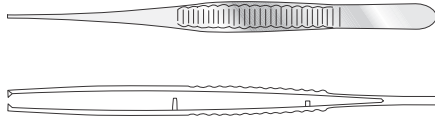

| Code | Description |
|-----------|-------------|
| Sb-PL/052 | 152mm long |

McIndoe Dissecting Forceps

152mm long

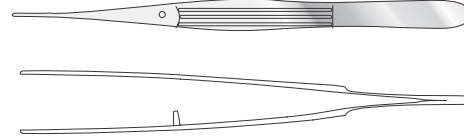

| Code | Description |
|-----------|-------------|
| Sb-GI/476 | Serrated |
| Sb-GI/477 | 1-2 teeth |

Jackson Burrows Dissecting Forceps

140mm long

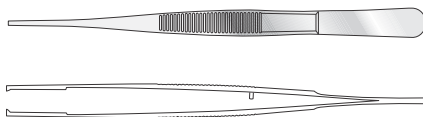

| Code | Description |
|-------------|------------------------------|
| Sb-OR/N037 | Tongue and groove, 1-2 teeth |
| Sb-OR/N037a | Tongue and groove only |

McIndoe Modified Dissecting Forceps

152mm long, 1mm tip, modified for fine powerful dissection with strong action tip

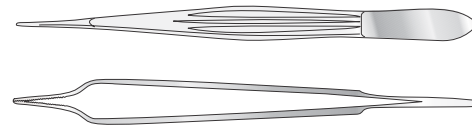

| Code | Description |
|---------|-------------|
| Sb/5961 | Serrated |

Jean Dissecting Forceps

Serrated jaws, 140mm long

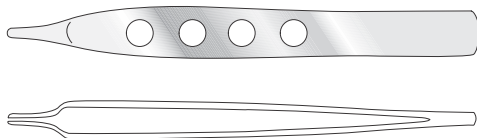

| Code | Description |
|-----------|-----------------------|
| Sb-GI/269 | Fine |
| Sb-GI/270 | 1-2 teeth |
| Sb-GI/271 | 2-3 teeth, 178mm long |

Treves Dissecting Forceps

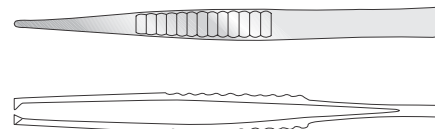

1-2 teeth

| Code | Description |
|-----------|-------------|
| Sb-GI/251 | 127mm long |
| Sb-GI/252 | 152mm long |

2-3 teeth

| Code | Description |
|-----------|-------------|
| Sb-GI/253 | 127mm long |
| Sb-GI/254 | 152mm long |

Lanes Dissecting Forceps

1-2 teeth on serrated jaws, 140mm long

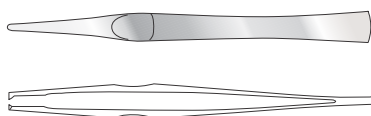

| Code | Description |
|-----------|-------------|
| Sb-GI/246 | 127mm long |
| Sb-GI/247 | 152mm long |
| Sb-GI/248 | 178mm long |

| Code | Description |
|-----------|-----------------------|
| Sb-GI/249 | 2-3 teeth, 178mm long |
| Sb-GI/250 | 2-3 teeth 203mm long |

Waugh Dissecting Forceps

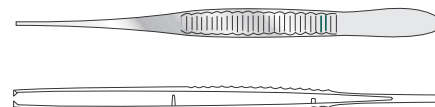

Fine, serrated

| Code | Description |
|-----------|-------------|
| Sb-GI/261 | 152mm long |
| Sb-GI/262 | 178mm long |
| Sb-GI/263 | 203mm long |

Fine, 1-2 teeth

| Code | Description |
|-----------|-------------|
| Sb-GI/264 | 152mm long |
| Sb-GI/265 | 178mm long |
| Sb-GI/266 | 203mm long |

TISSUE FORCEPS

STAHLÉAN BRAZIL
SAVING LIVES



Allis Tissue Forceps

Box joint

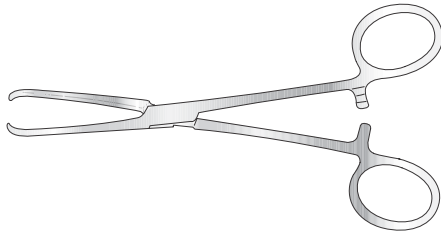

150mm long

| Code | Description |
|-----------|-------------|
| Sb-GI/272 | 3-4 teeth |
| Sb-GI/273 | 4-5 teeth |

190mm long

| Code | Description |
|-----------|-------------|
| Sb-GI/414 | 5-6 teeth |

Duval Tissue Forceps

Box joint

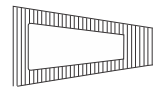
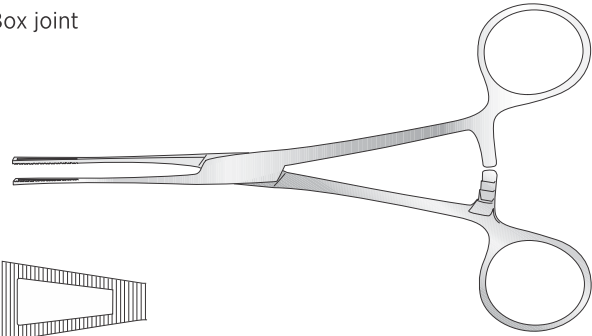

| Code | Description |
|-----------|-----------------------|
| Sb-GI/279 | 13mm wide, 203mm long |

Littlewood Tissue Forceps

Box joint, 2-3 teeth

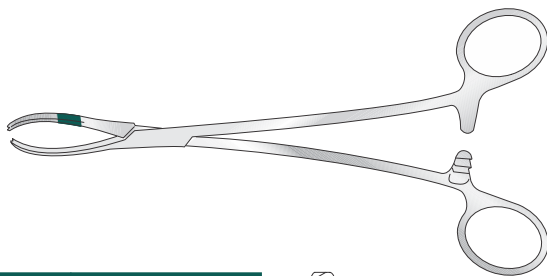

| Code | Description |
|-----------|-------------|
| Sb-GI/275 | 190mm long |



Lane Tissue Forceps

Box joint, 1-2 teeth, fenestrated

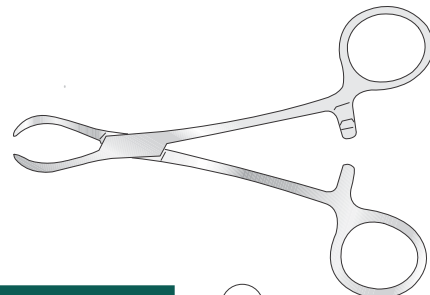

| Code | Description |
|-----------|-------------|
| Sb-GI/280 | 127mm long |
| Sb-GI/281 | 152mm long |
| Sb-GI/282 | 197mm long |



Babcock Tissue Forceps

Box joint, serrated jaws

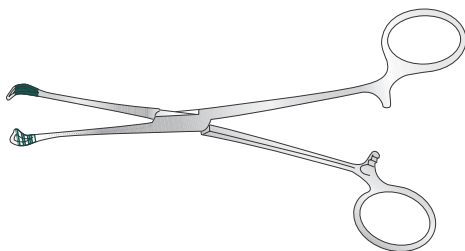

| Code | Description |
|-----------|-------------|
| Sb-GI/276 | 160mm long |
| Sb-GI/277 | 200mm long |
| Sb-GI/278 | 230mm long |

Rutherford Morrison Tissue Forceps

Box joint

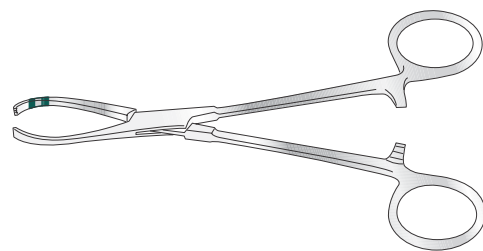

| Code | Description |
|-----------|-----------------------|
| Sb-GI/283 | 4-5 teeth, 152mm long |



TISSUE FORCEPS

STAHLÉAN BRAZIL
SAVING LIVES



Shaw Tissue Forceps

Box joint

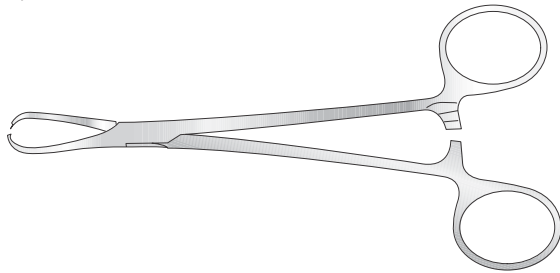

| Code | Description |
|-----------|-----------------------|
| Sb-GI/458 | 1-2 teeth, 178mm long |



Guys Gallabin Suture-Holding Forceps

Screw joint, angled flat blades

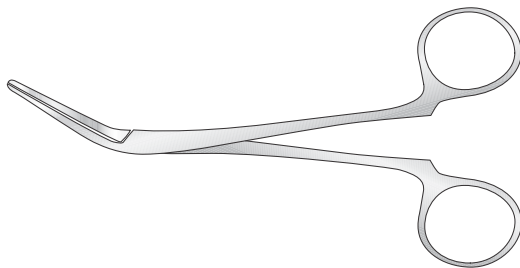

| Code | Description |
|------------|-------------|
| Sb-GI/450 | 125mm long |
| Sb-GI/4402 | 150mm long |

Russian Dissecting Forceps

With fenestrated end



| Code | Description |
|----------------|-------------|
| Sb-GI/SH-5503b | 150mm long |
| Sb-GI/SH-5503 | 200mm long |
| Sb-GI/403 | 230mm long |
| Sb-GI/SH-5503a | 250mm long |



Special Offer

on SSD Essentials Pack

Top up your trays with these essentials...

Halstead Mosquito Forceps

Straight/Curved
125mm (5")

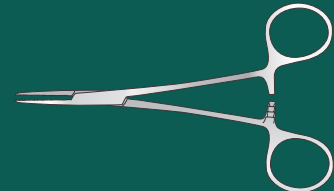

Rampléy Sponge Holding Forceps

Straight, Serrated
Jaws 241mm
(9½")

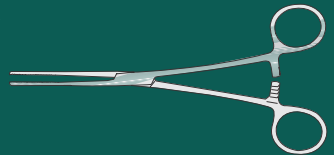

Scalpel Blade Handle

No. 3

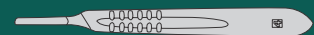

Spring Clip

Serrated Pattern,
Stainless Steel for
Fixing Slings to Leg
Splints, also for
Towel Clipping
6.3cm (2½") Wide

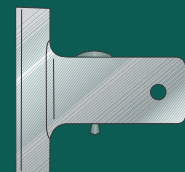

Spencer Wells Artery Forceps

Straight, Serrated
Jaws

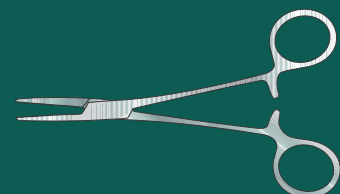

SPONGE HOLDING AND STERILISING FORCEPS



Rampley Sponge Holding Forceps

Box joint, straight, serrated jaws

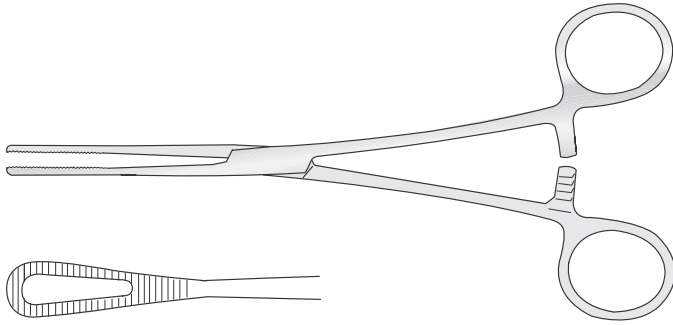

| Code | Description |
|-----------|-------------|
| Sb-GI/353 | 178mm long |
| Sb-GI/354 | 241mm long |

Lister Sinus Forceps

Box joint, serrated tip

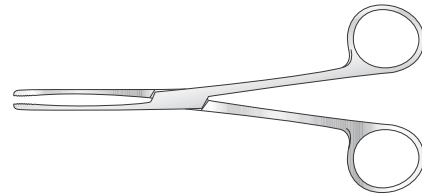

| Code | Description |
|-----------|-------------|
| Sb-GI/367 | 127mm long |
| Sb-GI/368 | 152mm long |
| Sb-GI/369 | 178mm long |

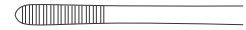

Foerster Sponge Holding Forceps

Box joint, straight, serrated jaws

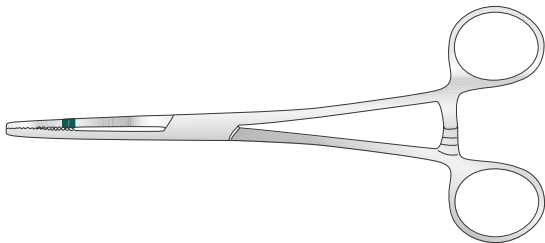

| Code | Description |
|------------|-------------|
| Sb-GI/354a | 178mm long |

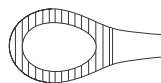

Cheatle Sterilizer Forceps

Screw joint

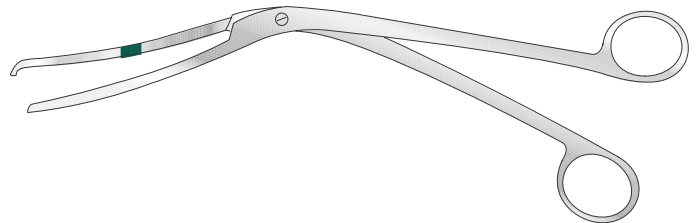

| Code | Description |
|-----------|-------------|
| Sb-GI/364 | 267mm long |

Harrison Bowl Steriliser Forceps

Screw joint, angled, double jaw

| Code | Description |
|-----------|-------------|
| Sb-GI/365 | 356mm long |
| Sb-GI/366 | 457mm long |

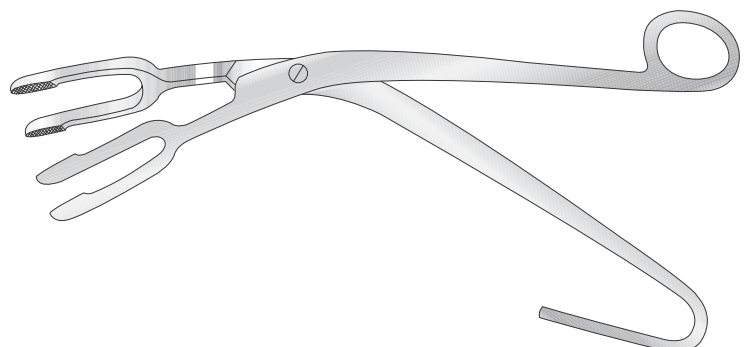

OTHER FORCEPS

STAHLEÁN BRAZIL
SAVING LIVES



Hunter Splinter Forceps

Serrated grooved pointed jaws



| Code | Description |
|-----------|-------------|
| Sb-GI/360 | 115mm long |

Michel Forceps

Box joint, double-ended, for inserting and removing clips stainless steel

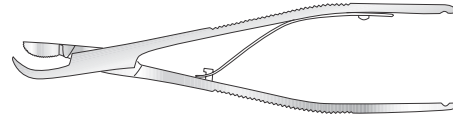

| Code | Description |
|-----------|-------------|
| Sb-GI/357 | 130mm long |

Michel Skin Holding Forceps

With magazine for Michel clips

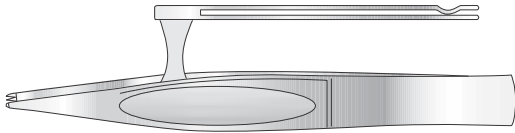

| Code | Description |
|-----------|-----------------------|
| Sb-GI/358 | 1-2 teeth, 127mm long |

Michel Clip Extracting Forceps

Box joint

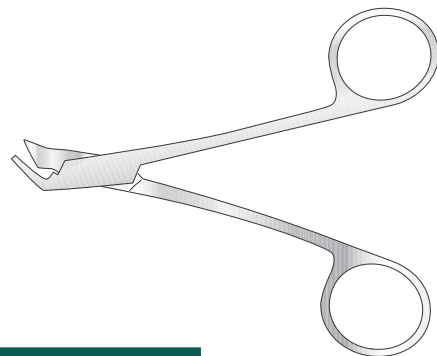

| Code | Description |
|-----------|-------------|
| Sb-GI/359 | 125mm long |

Childe Approximating Forceps

With magazine for Michel clips

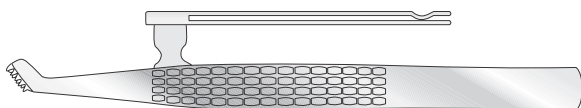

| Code | Description |
|-----------|-------------|
| Sb-GI/469 | 180mm long |

Robins Anchoring Forceps

140mm long

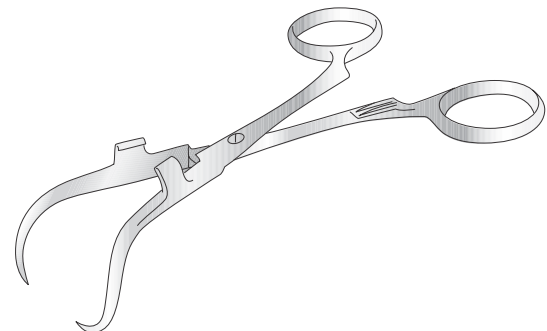

| Code | Description |
|------------|-------------------------------------|
| Sb-GI/453 | 5mm with holder for diathermy leads |
| Sb-GI/453a | 13mm with holder for suction tubing |

PREMIUM QUALITY STAINLESS STEEL SCISSORS

STAHLÉAN BRAZIL
SAVING LIVES



Dressing Scissors

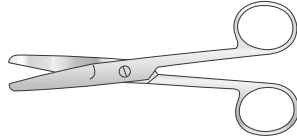

Blunt/Blunt

Straight

| Code | Description |
|-----------|-------------|
| Sb-GI/133 | 130mm long |
| Sb-GI/136 | 146mm long |
| Sb-GI/139 | 165mm long |

Curved

| Code | Description |
|-----------|-------------|
| Sb-GI/142 | 130mm long |
| Sb-GI/143 | 146mm long |
| Sb-GI/144 | 165mm long |
| Sb-GI/145 | 185mm long |
| Sb-GI/404 | 147mm long |

With one serrated blade

Blunt/Sharp

Straight

| Code | Description |
|-----------|-------------|
| Sb-GI/134 | 130mm long |
| Sb-GI/137 | 146mm long |
| Sb-GI/140 | 165mm long |

Sharp/Sharp

Straight

| Code | Description |
|-----------|-------------|
| Sb-GI/135 | 130mm long |
| Sb-GI/138 | 146mm long |
| Sb-GI/141 | 165mm long |

Curved

| Code | Description |
|-----------|-------------|
| Sb-GI/146 | 130mm long |

Metzenbaum Scissors

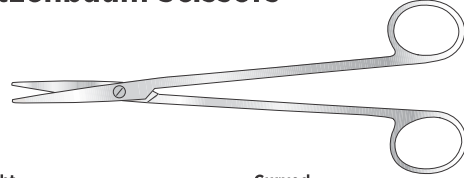

Straight

| Code | Description |
|------------|-------------|
| Sb-GI/405 | 180mm long |
| Sb-GI/406 | 147mm long |
| Sb-GI/406a | 200mm long |
| Sb-GI/406b | 230mm long |
| Sb-GI/406c | 250mm long |
| Sb-GI/406d | 280mm long |

Curved

| Code | Description |
|------------|-------------|
| Sb-GI/407 | 185mm long |
| Sb-GI/408 | 147mm long |
| Sb-GI/408a | 200mm long |
| Sb-GI/408b | 230mm long |
| Sb-GI/408c | 250mm long |
| Sb-GI/408d | 280mm long |

Dressing Scissors, Left-Handed

With one black bow, 145mm long

Blunt/Blunt

| Code | Description |
|-----------|-------------|
| Sb-GI/192 | Straight |
| Sb-GI/193 | Curved |

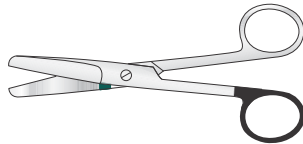

Blunt/Sharp

| Code | Description |
|-----------|-------------|
| Sb-GI/194 | Straight |
| Sb-GI/195 | Curved |

Sharp/Sharp

| Code | Description |
|-----------|-------------|
| Sb-GI/196 | Straight |
| Sb-GI/197 | Curved |

Little Dissecting Scissors

Fine pattern, with eye for suture

| Code | Description |
|------------|-------------|
| Sb-PL/001f | 115mm long |

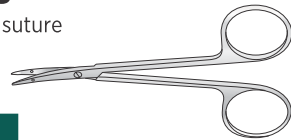

Kilner Dissecting Scissors

Fine pattern

| Code | Description |
|------------|-------------|
| Sb-PL/001a | 115mm long |

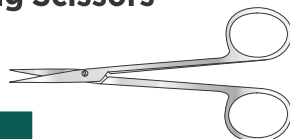

Mayo Scissors

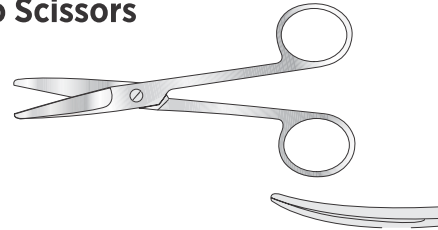

Straight

| Code | Description |
|------------|-------------|
| Sb-GI/409 | 140mm long |
| Sb-GI/409a | 160mm long |
| Sb-GI/411 | 190mm long |
| Sb-GI/411a | 230mm long |

Curved

| Code | Description |
|------------|-------------|
| Sb-GI/410 | 140mm long |
| Sb-GI/410a | 160mm long |
| Sb-GI/412 | 190mm long |
| Sb-GI/412a | 230mm long |

Fergusson Scissors

Angled on flat

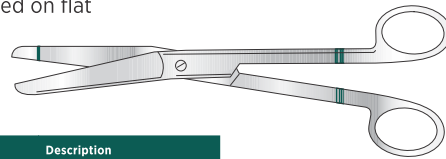

| Code | Description |
|-----------|-------------|
| Sb-GI/148 | 180mm long |

Paynes Suture Scissors

| Code | Description |
|-----------|-------------|
| Sb-GI/152 | 100mm long |

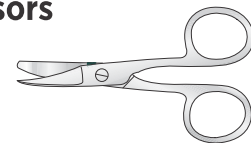

Ligature Stitch Scissors

Fine pattern

| Code | Description |
|-----------|-------------|
| Sb-GI/153 | 115mm long |

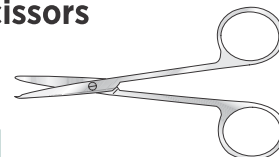

SCISSORS

STAHLÉAN BRAZIL
SAVING LIVES



Lister Bandage Scissors

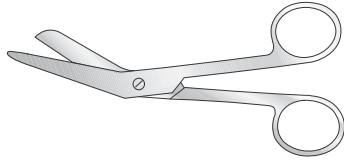

| Code | Description |
|-----------|-------------|
| Sb-GI/154 | 147mm long |
| Sb-GI/155 | 178mm long |

Lister Bandage Scissors

Angled, with probe end

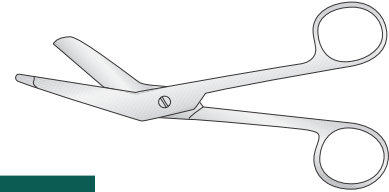

| Code | Description |
|-----------|-------------|
| Sb-GI/361 | 147mm long |
| Sb-GI/362 | 178mm long |

McIndoe Scissors

178mm long

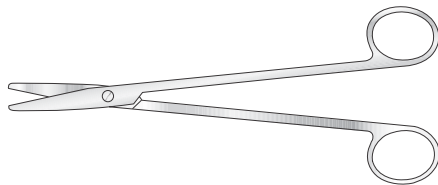

| Code | Description |
|-------------|------------------|
| Sb-GI/149 | Straight |
| Sb-GI/150 | Curved on flat |
| Sb-GI/150sc | Supercut, curved |



Thomas Strabismus Scissors

114mm long

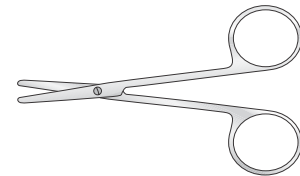

| Code | Description |
|-----------|-------------|
| Sb-OP/030 | Straight |
| Sb-OP/029 | Curved |

Heath Stitch Scissors

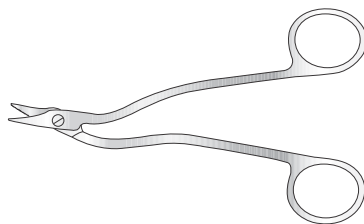

| Code | Description |
|-----------|-------------|
| Sb-GI/151 | 152mm long |

“Careless” Scissors

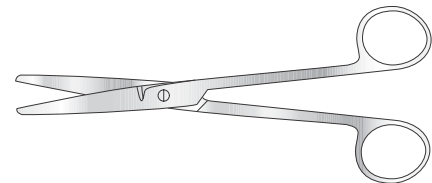

| Code | Description |
|-----------|-------------|
| Sb-GI/474 | 165mm long |

Tubing Scissors

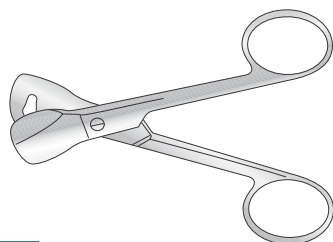

| Code | Description |
|-----------|-------------|
| Sb-GI/147 | 130mm long |

Utility Scissors



| Code | Description |
|-----------|-------------|
| Sb-GI/466 | 190mm long |

TUNGSTEN CARBIDE HARD INSERT SCISSORS

STAHLÉAN BRAZIL
SAVING LIVES



Dressing Scissors

Tungsten carbide hard insert, blunt/blunt

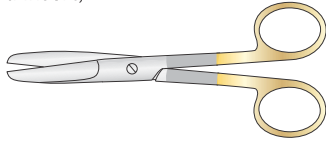

Straight

| Code | Description |
|-----------|-------------|
| Sb-GI/430 | 130mm long |
| Sb-GI/432 | 145mm long |
| Sb-GI/434 | 165mm long |
| Sb-GI/436 | 185mm long |

Curved

| Code | Description |
|-----------|-------------|
| Sb-GI/431 | 130mm long |
| Sb-GI/433 | 145mm long |
| Sb-GI/435 | 165mm long |

Mayo Dressing Scissors

Tungsten carbide hard insert

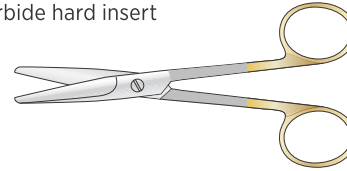

Straight

| Code | Description |
|------------|-------------|
| Sb-GI/419 | 140mm long |
| Sb-GI/419a | 160mm long |
| Sb-GI/421 | 190mm long |
| Sb-GI/421a | 230mm long |

Curved

| Code | Description |
|------------|-------------|
| Sb-GI/420 | 140mm long |
| Sb-GI/420a | 160mm long |
| Sb-GI/422 | 190mm long |
| Sb-GI/422a | 230mm long |

Dressing Scissors

Tungsten carbide hard insert, blunt/sharp

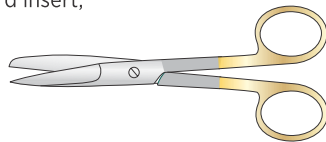

Straight

| Code | Description |
|-----------|-------------|
| Sb-GI/423 | 130mm long |
| Sb-GI/425 | 145mm long |
| Sb-GI/427 | 165mm long |
| Sb-GI/429 | 185mm long |

Curved

| Code | Description |
|-----------|-------------|
| Sb-GI/424 | 130mm long |
| Sb-GI/426 | 145mm long |
| Sb-GI/428 | 165mm long |

Mayo-Harrington Dressing Scissors

Tungsten carbide hard insert

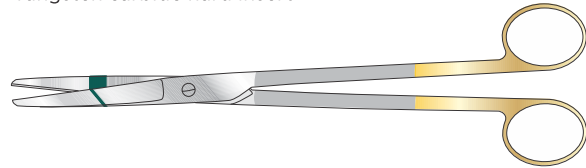

230mm long

| Code | Description |
|-----------|-------------|
| Sb-GI/417 | Straight |
| Sb-GI/418 | Curved |

200mm long

| Code | Description |
|------------|-------------|
| Sb-GI/162a | Straight |
| Sb-GI/413b | Curved |

Dressing Scissors

Tungsten carbide hard insert sharp/sharp

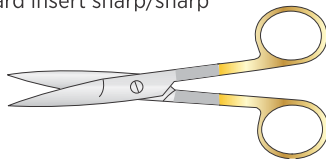

Straight

| Code | Description |
|-----------|-------------|
| Sb-GI/437 | 130mm long |
| Sb-GI/439 | 145mm long |
| Sb-GI/441 | 165mm long |
| Sb-GI/443 | 185mm long |

Curved

| Code | Description |
|-----------|-------------|
| Sb-GI/438 | 130mm long |
| Sb-GI/440 | 145mm long |
| Sb-GI/442 | 165mm long |

Metzenbaum Scissors

Tungsten carbide hard insert

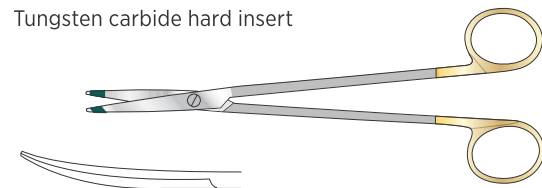

230mm long

| Code | Description |
|------------|-------------|
| Sb-GI/445 | 145mm long |
| Sb-GI/448 | 185mm long |
| Sb-GI/471a | 230mm long |
| Sb-GI/471b | 250mm long |
| Sb-GI/471c | 280mm long |

200mm long

| Code | Description |
|------------|-------------|
| Sb-GI/446 | 145mm long |
| Sb-GI/449 | 185mm long |
| Sb-GI/449a | 200mm long |
| Sb-GI/449b | 230mm long |
| Sb-GI/449c | 250mm long |
| Sb-GI/449d | 280mm long |

Baby Metzenbaum Scissors

Tungsten carbide, hard insert, 145mm long

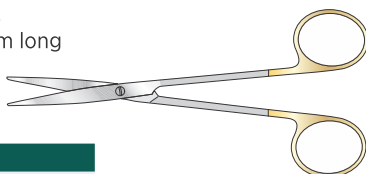

| Code | Description |
|------------|-------------|
| Sb-GI/445a | Straight |
| Sb-GI/446a | Curved |

Ligature Scissors

Tungsten carbide hard insert, curved

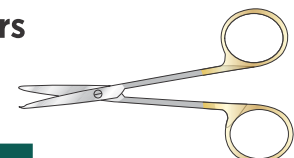

| Code | Description |
|-----------|-------------|
| Sb-GI/444 | 145mm long |
| Sb-GI/447 | 185mm long |

TUNGSTEN CARBIDE SUPERCUT SCISSORS

STAHLÉAN BRAZIL
SAVING LIVES



Mayo Harrington Scissors

Supercut, tungsten carbide

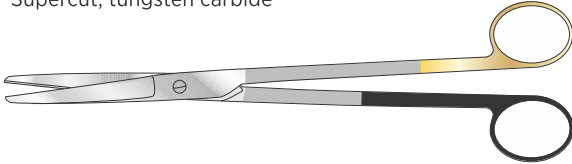

230mm long

| Code | Description |
|-----------|-------------|
| Sb-GI/162 | Straight |
| Sb-GI/413 | Curved |

200mm long

| Code | Description |
|------------|-------------|
| Sb-GI/162b | Straight |
| Sb-GI/413b | Curved |

Dressing Scissors

Supercut, tungsten carbide

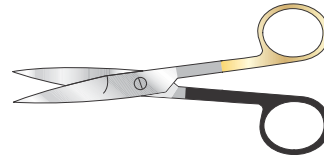

Blunt/Blunt

Straight

| Code | Description |
|-----------|-------------|
| Sb-GI/174 | 130mm long |
| Sb-GI/176 | 145mm long |
| Sb-GI/178 | 165mm long |
| Sb-GI/180 | 185mm long |

Curved

| Code | Description |
|------------|-------------|
| Sb-GI/175 | 130mm long |
| Sb-GI/177 | 145mm long |
| Sb-GI/179 | 165mm long |
| Sb-GI/180a | 185mm long |

Mayo Scissors

Supercut, tungsten carbide

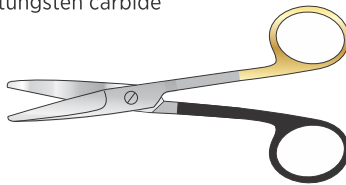

Straight

| Code | Description |
|------------|-------------|
| Sb-GI/163 | 140mm long |
| Sb-GI/163a | 160mm long |
| Sb-GI/165 | 190mm long |
| Sb-GI/165a | 230mm long |

Curved

| Code | Description |
|------------|-------------|
| Sb-GI/164 | 140mm long |
| Sb-GI/164a | 160mm long |
| Sb-GI/166 | 190mm long |
| Sb-GI/166a | 230mm long |

Blunt/Sharp

Straight

| Code | Description |
|-----------|-------------|
| Sb-GI/167 | 130mm long |
| Sb-GI/169 | 145mm long |
| Sb-GI/171 | 165mm long |
| Sb-GI/173 | 185mm long |

Curved

| Code | Description |
|------------|-------------|
| Sb-GI/168 | 130mm long |
| Sb-GI/170 | 145mm long |
| Sb-GI/172 | 165mm long |
| Sb-GI/173a | 185mm long |

Sharp/Sharp

Straight

| Code | Description |
|-----------|-------------|
| Sb-GI/181 | 130mm long |
| Sb-GI/183 | 145mm long |
| Sb-GI/185 | 165mm long |
| Sb-GI/187 | 185mm long |

Curved

| Code | Description |
|------------|-------------|
| Sb-GI/182 | 130mm long |
| Sb-GI/184 | 145mm long |
| Sb-GI/186 | 165mm long |
| Sb-GI/187a | 185mm long |

Metzenbaum Dissecting Scissors

Supercut, tungsten carbide

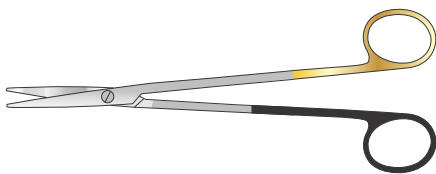

Straight

| Code | Description |
|--------------|-------------|
| Sb-GI/188tc | 185mm long |
| Sb-GI/188tca | 200mm long |
| Sb-GI/188tcb | 230mm long |
| Sb-GI/188tcc | 250mm long |
| Sb-GI/188tcd | 280mm long |

Curved

| Code | Description |
|--------------|-------------|
| Sb-GI/191tc | 147mm |
| Sb-GI/189tc | 185mm |
| Sb-GI/186tca | 200mm |
| Sb-GI/188tcb | 230mm |
| Sb-GI/188tcc | 250mm |
| Sb-GI/188tcd | 280mm |

Guide for Gold and Black Bows

It's important to know the difference for the intended use of each scissor:



2 Gold Bows
Tungsten carbide insert or padding for a scissor



2 Black Bows
Supercut edge



1 Black and 1 Gold Bow
Supercut tungsten carbide



1 Black Bow (left ring)
Left-handed instrument carbide

SUPERCUT OPERATING SCISSORS

STAHLÉAN BRAZIL
SAVING LIVES



Dressing Scissors

Supercut, blunt/blunt



145mm long

| Code | Description |
|-----------|-------------|
| Sb-GI/160 | Straight |
| Sb-GI/161 | Curved |

Dressing Scissors

Supercut, blunt/sharp

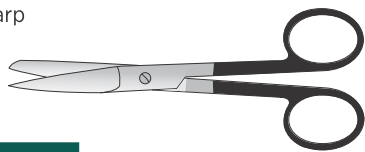

145mm long

| Code | Description |
|-----------|-------------|
| Sb-GI/156 | Straight |
| Sb-GI/157 | Curved |

Dressing Scissors

Supercut, sharp/sharp



145mm long

| Code | Description |
|-----------|-------------|
| Sb-GI/158 | Straight |
| Sb-GI/159 | Curved |

Mayo Scissors

Supercut

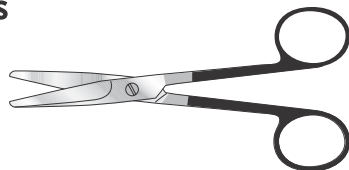

Straight

| Code | Description |
|------------|-------------|
| Sb-GI/166a | 140mm long |
| Sb-GI/166e | 160mm long |
| Sb-GI/166b | 170mm long |

Curved

| Code | Description |
|------------|-------------|
| Sb-GI/166c | 140mm long |
| Sb-GI/166f | 160mm long |
| Sb-GI/166d | 170mm long |

Boyd Scissors

Supercut, blunt/blunt

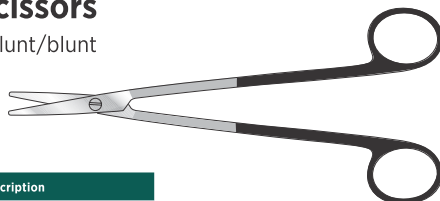

| Code | Description |
|------------|-------------|
| Sb-THO/047 | 180mm long |

Metzenbaum Dissecting Scissors

Supercut

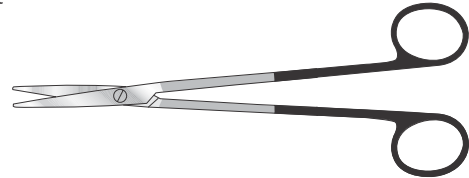

Straight (length)

| Code | Description |
|------------|-------------|
| Sb-GI/190 | 147mm |
| Sb-GI/188 | 185mm |
| Sb-GI/188a | 200mm |
| Sb-GI/188b | 230mm |
| Sb-GI/188c | 250mm |
| Sb-GI/188d | 280mm |

Curved (length)

| Code | Description |
|------------|-------------|
| Sb-GI/191 | 147mm |
| Sb-GI/189 | 185mm |
| Sb-GI/186a | 200mm |
| Sb-GI/186b | 230mm |
| Sb-GI/186c | 250mm |
| Sb-GI/186d | 280mm |

Stevens Tenotomy Scissors

Supercut



Curved/blunt

| Code | Description |
|-------------|-------------|
| Sb-OP/424 | 114mm long |
| Sb-OP/424a | 125mm long |
| Sb-OP/424gb | 135mm long |

Curved/sharp

| Code | Description |
|------------|-------------|
| Sb-OP/425 | 114mm long |
| Sb-OP/425a | 140mm long |
| Sb-OP/425b | 160mm long |

With cutout, 110mm long

| Code | Description |
|------------|----------------------------|
| Sb-OP/426 | Straight/blunt, 114mm long |
| Sb-OP/427 | Straight/sharp, 114mm long |
| Sb-OP/427c | Straight/sharp, 180mm long |

With cutout, 110mm long

| Code | Description |
|------------|----------------|
| Sb-OP/427a | Straight/blunt |
| Sb-OP/427b | Curved/blunt |

Strabismus Scissors

Supercut

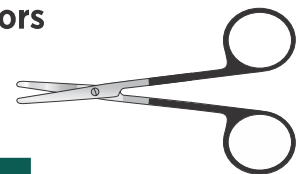

114mm long

| Code | Description |
|------------|-------------|
| Sb-GI/475 | Straight |
| Sb-GI/475a | Curved |

Iris Scissors

Supercut

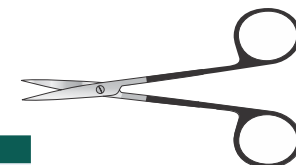

114mm long

| Code | Description |
|------------|-------------|
| Sb-OP/476 | Straight |
| Sb-OP/476a | Curved |

NEEDLE HOLDERS

STAHLÉAN BRAZIL
SAVING LIVES



Bruce Clarke Needle Holder

Screw joint

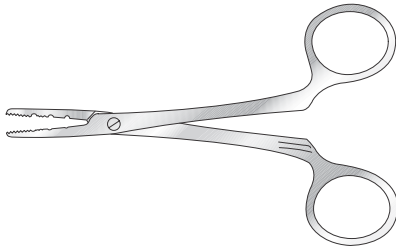

| Code | Description |
|-----------|-------------|
| Sb-GI/205 | 127mm long |

Lawrence Needle Holder

Fine jaw, 150mm long

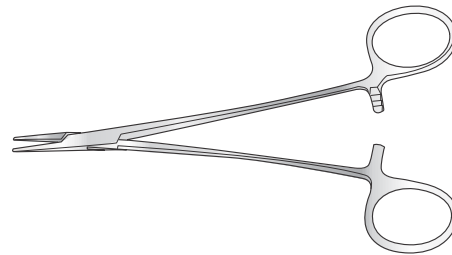

| Code | Description |
|------------|----------------------|
| Sb-PL/012a | |
| Sb-PL/012b | Tungsten carbide jaw |

Crile-Wood Needle Holder

Straight, baby, fine

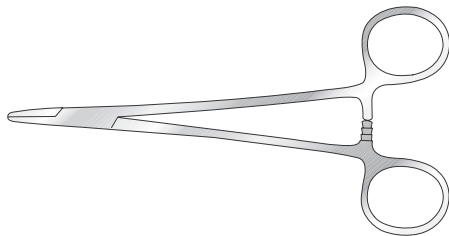

| Code | Description |
|-----------|-------------|
| Sb-GI/199 | 150mm long |

Needle Holder

Surgical Holdings pattern, box joint, lightweight, with curved plain jaws and one offset bow for thumb

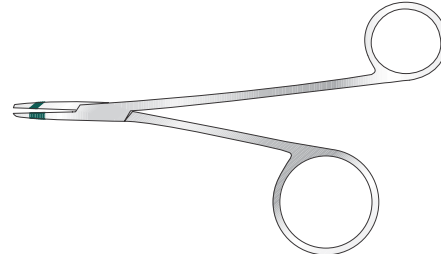

| Code | Description |
|-----------|-------------|
| Sb-GI/209 | 152mm long |

Kilner Needle Holder

Box joint, cross-serrated jaw

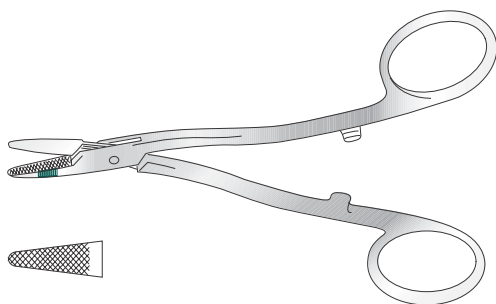

| Code | Description |
|-----------|-------------|
| Sb-GI/200 | 165mm long |
| Sb-GI/201 | 133mm long |

MacPhail Needle Holder

Screw joint, with one copper jaw

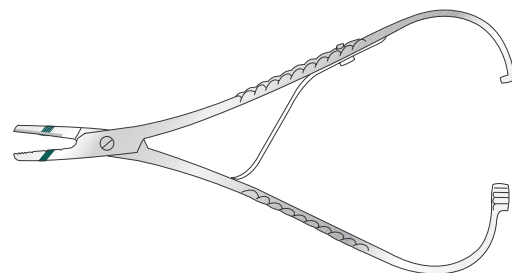

| Code | Description |
|-----------|-------------|
| Sb-GI/206 | 159mm long |
| Sb-GI/207 | 178mm long |
| Sb-GI/208 | 209mm long |

NEEDLE HOLDERS

STAHLÉAN BRAZIL
SAVING LIVES



Mathieu Needle Holder

Screw joint

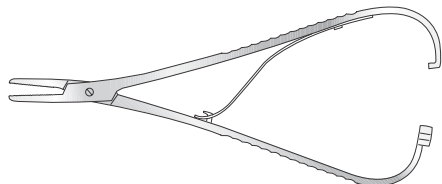

| Code | Description |
|-----------|-------------|
| Sb-GI/210 | 172mm long |
| Sb-GI/211 | 209mm long |
| Sb-GI/212 | 243mm long |

Naughton Morgan Needle Holder

Box joints, cross serrated jaws

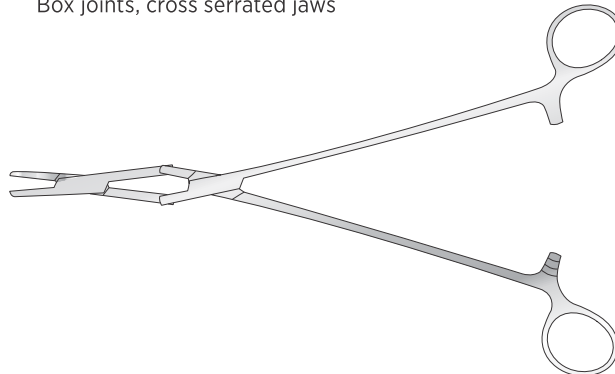

Mayo Needle Holder

Box joint, straight

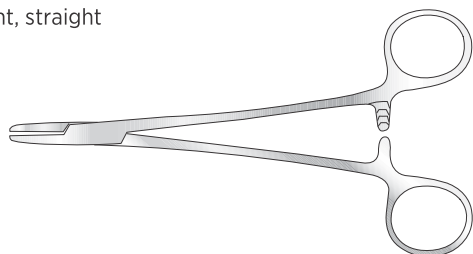

Wide cross serrated jaws

| Code | Description |
|-----------|-------------|
| Sb-GI/224 | 159mm long |
| Sb-GI/398 | 203mm long |



Narrow cross serrated jaws

| Code | Description |
|-----------|-------------|
| Sb-GI/225 | 159mm long |

Tungsten carbide

| Code | Description |
|-----------|-------------|
| Sb-GI/399 | 185mm long |
| Sb-GI/400 | 254mm long |

| Code | Description |
|-----------|-------------|
| Sb-GI/401 | 185mm long |
| Sb-GI/402 | 254mm long |

Rochester-Mayo Needle Holder

Screw joint

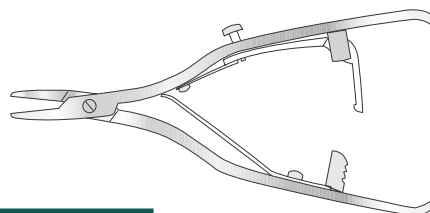

| Code | Description |
|-----------|-------------|
| Sb-GI/213 | 178mm long |

Choosing the most suitable needle size

Our tungsten carbide inserts are available in a variety of styles. Choosing the most suitable needle size for each procedure helps give the surgeon maximum grip and control.

Coarse 0.65mm

For powerful needle holder patterns and wire twisters. Maximum holding capabilities for heavy needles or wire.



Standard 0.5mm

Used, for example, in Mayo-Hegar, Mathieu Needle Holders. For needles 3-0 and larger.



Fine 0.4mm

For delicate needle holders such as Crile-Wood and DeBakey. For needles and sutures between 4-0 and 6-0.



Micro 0.2-0.3mm

For micro needle holders such as Castroviejo, Microvascular and Mini-Ryder. For delicate needles and sutures between 7-0 and 10-0.



Smooth

Smooth tungsten carbide surface reduces damage to delicate needles and suture of 6-0 and finer.



TUNGSTEN CARBIDE NEEDLE HOLDERS

Berry Needle Holder/Wire Twister

Tungsten carbide jaws

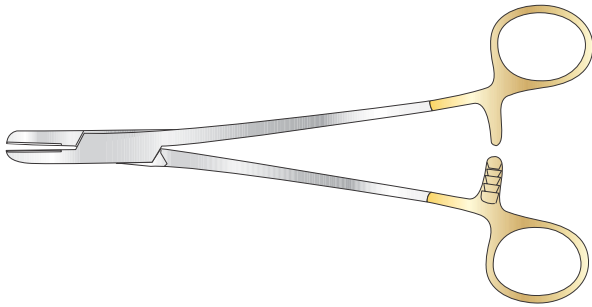

| Code | Description |
|-----------|-------------|
| Sb-GI/467 | 200mm long |

Finochietto Needle Holder

Tungsten carbide jaws

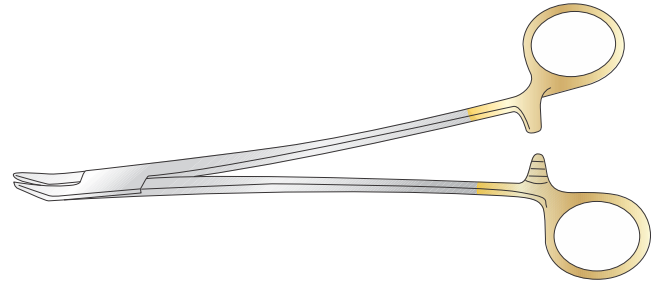

| Code | Description |
|-----------|-------------|
| Sb-GI/222 | 215mm long |
| Sb-GI/223 | 265mm long |

Crile-Wood Needle Holder

Tungsten carbide insert, box joint, satin finish, straight

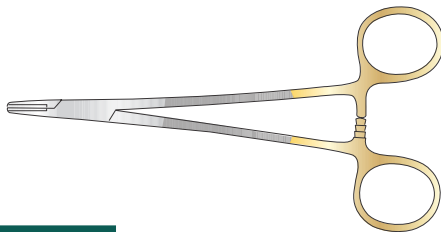

| Code | Description |
|-----------|-------------|
| Sb-GI/217 | 159mm long |
| Sb-GI/218 | 178mm long |
| Sb-GI/198 | 150mm long |

Halsey Needle Holder

Tungsten carbide insert, box joint, satin finish, straight

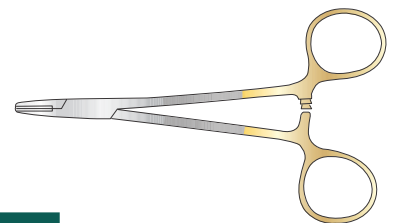

| Code | Description |
|-----------|-------------|
| Sb-GI/220 | 127mm long |

Derf Needle Holder

Tungsten carbide insert

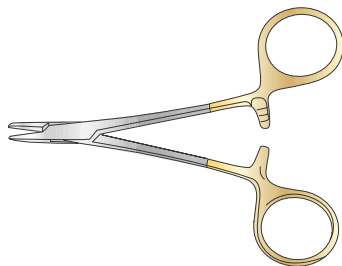

| Code | Description |
|----------------|-------------|
| Sb-GI/BUPHF002 | 115mm long |

Kilner Needle Holder

Tungsten carbide insert

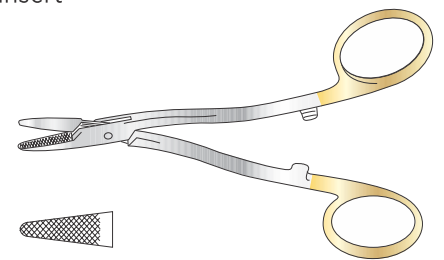

| Code | Description |
|-----------|-------------|
| Sb-GI/221 | 140mm long |

TUNGSTEN CARBIDE NEEDLE HOLDERS

Masing Needle Holder

Tungsten carbide insert, one angled bow

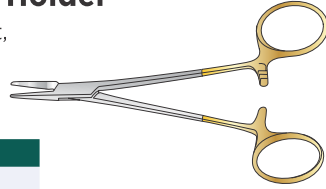

| Code | Description |
|------------|-------------|
| Sb-GI/009R | 130mm long |

Nievert Needle Holder

Tungsten carbide insert, box joint, satin finish, straight

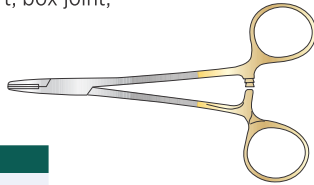

| Code | Description |
|-----------|-------------|
| Sb-GI/219 | 127mm long |

DeBakey Needle Holder

250mm long

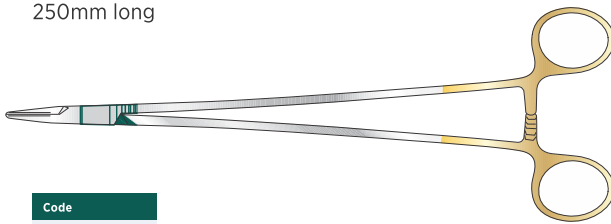

| Code |
|---------------|
| THO/ SI-5642a |

Ryder Needle Holder

Tungsten carbide insert, box joint, satin finish, straight

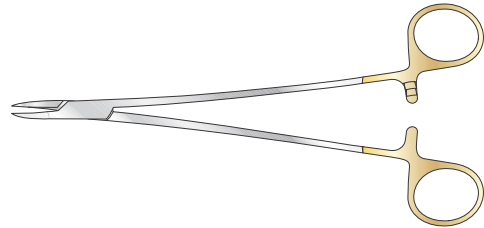

0.2mm jaw pitch

| Code | Description |
|----------------|-------------|
| Sb-GI/SH-5197a | 135mm long |
| Sb-GI/SH-5197b | 155mm long |
| Sb-GI/SH-5197c | 175mm long |
| Sb-GI/SH-5197d | 210mm long |

0.4mm jaw pitch

| Code | Description |
|----------------|-------------|
| Sb-GI/SH-5198a | 135mm long |
| Sb-GI/SH-5198b | 155mm long |
| Sb-GI/SH-5198c | 175mm long |
| Sb-GI/SH-5198d | 210mm long |

Sarot Needle Holder

Diamond jaw, tungsten carbide, gold plated bows

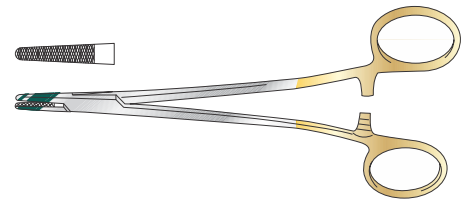

| Code | Description |
|-----------|-------------|
| Sb-GI/451 | 181mm long |

Mayo-Hegar Needle Holder

Tungsten carbide insert, box joint, satin finish, straight

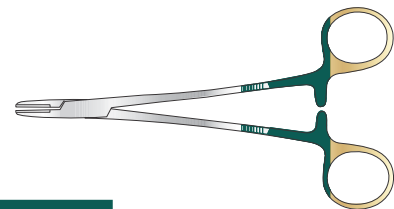

| Code | Description |
|-----------|-------------|
| Sb-GI/472 | 130mm long |
| Sb-GI/214 | 159mm long |
| Sb-GI/215 | 178mm long |
| Sb-GI/216 | 209mm long |

LONGER SIZES AVAILABLE

Tungsten Carbide Needle Holders

Features and Benefits

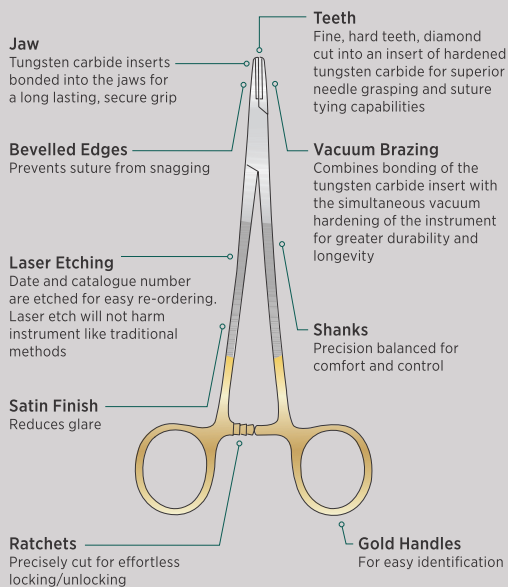

COMBINED SCISSOR AND NEEDLE HOLDERS

STAHLÉAN BRAZIL
SAVING LIVES



Olsen-Hegar Scissor/Needle Holder

With tungsten carbide insert

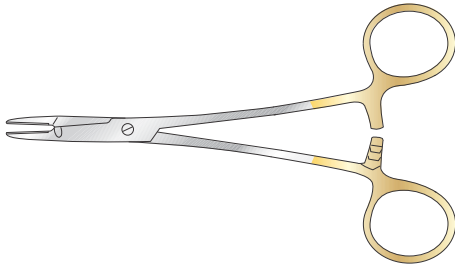

| Code | Description |
|-----------|-------------|
| Sb-GI/229 | 147mm long |
| Sb-GI/230 | 165mm long |

Olsen-Hegar Scissor/Needle Holder

Screw joint

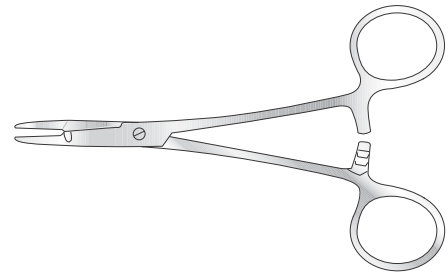

| Code | Description |
|-----------|-------------|
| Sb-GI/226 | 140mm long |
| Sb-GI/227 | 165mm long |
| Sb-GI/228 | 190mm long |

Gillies Scissor/Needle Holder

Right-hand, with tungsten carbide insert

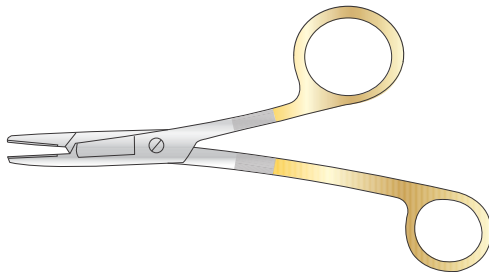

| Code | Description |
|-----------|-------------|
| Sb-GI/235 | 158mm long |

Gillies Scissor/Needle Holder

Heavy pattern, 158mm long



| Code | Description |
|-----------|-------------|
| Sb-GI/233 | Right-hand |
| Sb-GI/234 | Left-hand |

Gillies Scissor/Needle Holder

158mm long

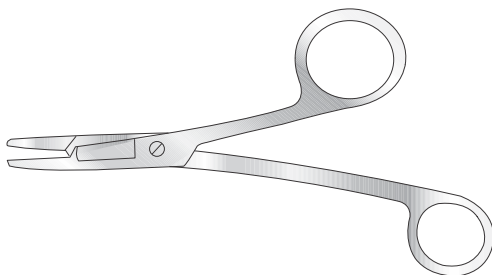

| Code | Description |
|-----------|-------------|
| Sb-GI/231 | Right-hand |
| Sb-GI/232 | Left-hand |

Foster Gillies Scissor/Needle Holder

Fine pattern

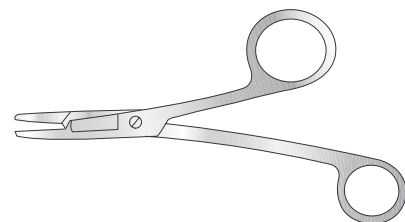

| Code | Description |
|-----------|-------------|
| Sb-GI/236 | 127mm long |

RONGEURS

STAHLÉAN BRAZIL
SAVING LIVES



Beck Rongeur

Straight, for intervertebral disc

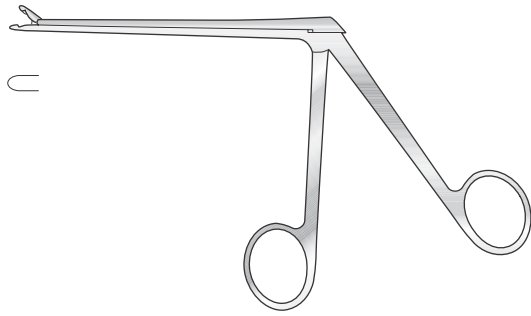

| Code | Description |
|------------|-----------------------|
| Sb-NEU/125 | 2mm bite, 130mm shaft |

Pennybacker Rongeur

120mm shaft

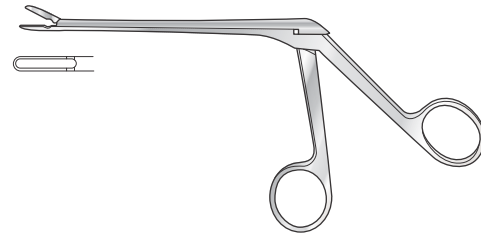

| Code | Description |
|------------|-------------|
| Sb-NEU/133 | 3mm bite |
| Sb-NEU/107 | 4mm bite |

Cushing Rongeur

130mm shaft



| Code | Description |
|--------------|-------------|
| Sb-NEU/127-2 | 2mm bite |
| Sb-NEU/127-3 | 3mm bite |
| Sb-NEU/127-4 | 4mm bite |
| Sb-NEU/127-5 | 5mm bite |
| Sb-NEU/127-6 | 6mm bite |



St Bart's Rongeur

114mm shaft

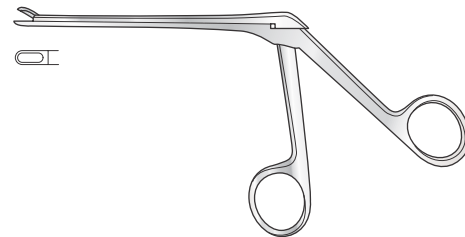

| Code | Description |
|-------------|-------------|
| Sb-ENT/140a | 3mm bite |

Cushing Rongeur

130mm shaft

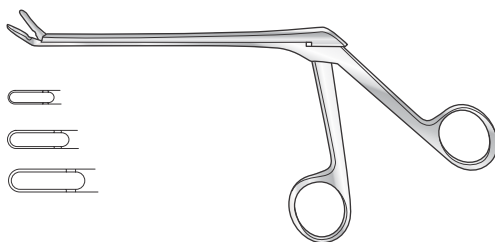

150° upward cutting

| Code | Description |
|-------------|-------------|
| Sb-NEU/128c | 2mm bite |
| Sb-NEU/128 | 3mm bite |
| Sb-NEU/128a | 4mm bite |
| Sb-NEU/128b | 5mm bite |

150° downward cutting

| Code | Description |
|-------------|-------------|
| Sb-NEU/130c | 2mm bite |
| Sb-NEU/130 | 3mm bite |
| Sb-NEU/130a | 4mm bite |
| Sb-NEU/130b | 5mm bite |

St Bart's Rongeur

140°, 3mm, 114mm shaft

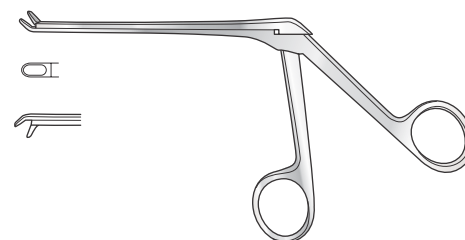

| Code | Description |
|--------------|------------------|
| Sb-ENT/140b | Upward cutting |
| Sb-ENT/140ac | Downward cutting |

BAG AND TOWEL CLIPS

STAHLÉAN BRAZIL
SAVING LIVES



Spring Clip

Serrated pattern, stainless steel, for fixing slings to leg splints, also for towel clipping

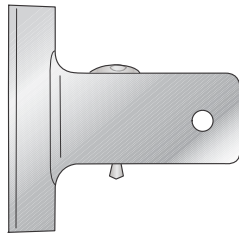

| Code | Description |
|-----------|-------------|
| Sb-GI/344 | 63mm wide |

Spring Bag Clip

Serrated

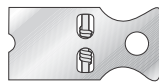

| Code | Description |
|-----------|-------------|
| Sb-GI/345 | 26mm wide |

Jones Towel Clip

Superior quality spring forcep type

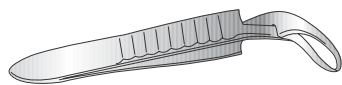

| Code | Description |
|-----------|-------------|
| Sb-GI/346 | 89mm long |

Shardles Towel Clip

Spring curved, cross action

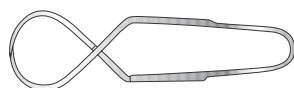

| Code | Description |
|-----------|-------------|
| Sb-GI/347 | 77mm long |

Backhaus Towel Clip

Superior quality, box joint

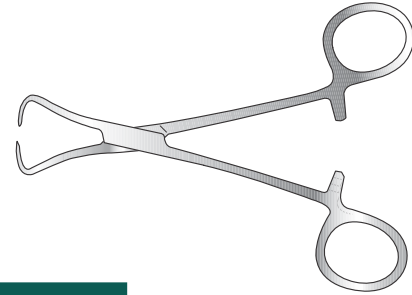

| Code | Description |
|------------|-------------|
| Sb-GI/348 | 89mm long |
| Sb-GI/348a | 102mm long |
| Sb-GI/349 | 130mm long |

Moynihan Towel Clip

Screw joint, 2-2 teeth, for sides of incision

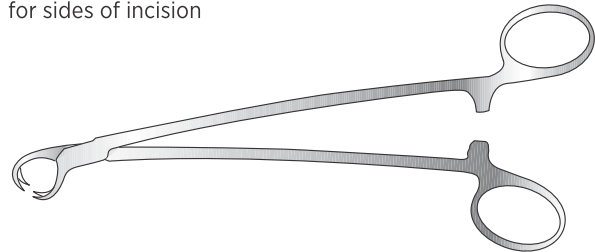

| Code | Description |
|-----------|-------------|
| Sb-GI/470 | 191mm long |

Ball and Socket Towel Forceps

Box joint

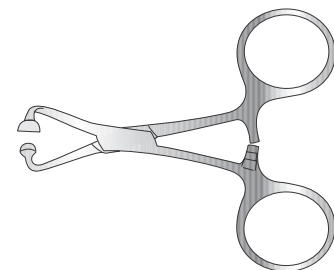

| Code | Description |
|-----------|-------------|
| Sb-GI/350 | 89mm long |
| Sb-GI/351 | 115mm long |
| Sb-GI/352 | 140mm long |

RETRACTORS

STAHLÉAN BRAZIL
SAVING LIVES



Goligher Retractor

Complete with 2 centre blades:
1 x 90mm wide x 50mm deep
1 x 90mm wide x 90mm deep

and 2 pairs of lateral blades:
1 pair 25mm wide x 45mm deep
1 pair 50mm wide x 90mm deep

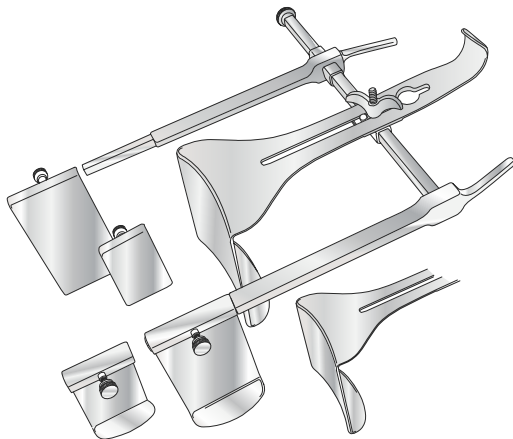

Code

Sb-GI/305

Balfour Abdominal Retractor

Trivalve, frame 203mm

Child

102mm opening, 51mm deep lateral blades,
38mm deep centre blade

Adult

178mm opening, 64mm deep lateral blades,
44mm deep centre blade

Extra large

178mm opening, 102mm deep lateral blades,
108mm deep centre blade

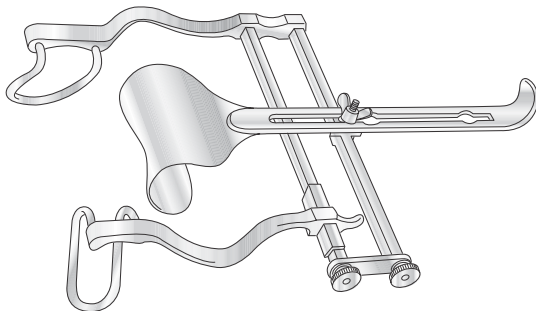

Code

Sb-GI/373 Child

Sb-GI/374 Adult

Sb-GI/375 Extra large

Miles Retractor

Complete with 2 centre blades:
1 x 90mm wide x 50mm deep
1 x 90mm wide x 75mm deep

and 2 pairs of lateral blades:
1 pair 80mm wide x 35mm deep
1 pair 80mm wide x 75mm deep

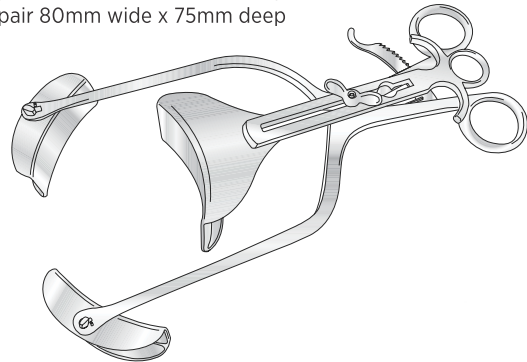

Code

Sb-GI/376 340mm long

OTHER BLADE SIZES AVAILABLE

Balfour Abdominal Retractor

Bivalve, baby

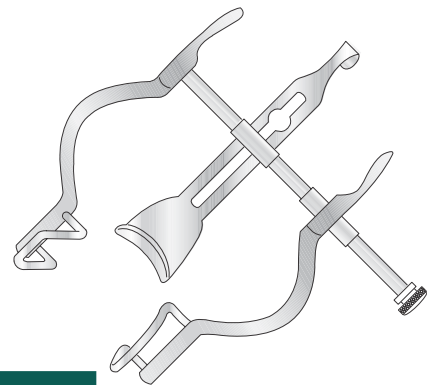

Code

Sb-GI/372 Fully open 89mm

Berkeley Abdominal Retractor

Parallel action

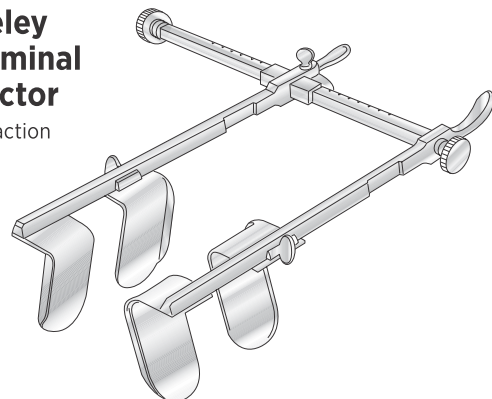

Code

Sb-GI/461 Blades 35mm x 60mm deep, 215mm long

TURNER WARWICK RETRACTORS

STAHLÉAN BRAZIL
SAVING LIVES



Turner Warwick Universal Self Retaining Retractor

| Code | Description |
|-------------|--|
| Sb-GI/520 | With frames A/B/C/D and blades A/B/C/D/E/F/K/L |
| Sb-GI/521-A | Circular frame A only 178mm |
| Sb-GI/521-B | Circular frame B only 229mm |
| Sb-GI/521-C | Circular frame C only 305mm |
| Sb-GI/521-D | Oval frame D only 475mm x 330mm |
| Sb-GI/521-E | Oval frame E only 370mm x 300mm |

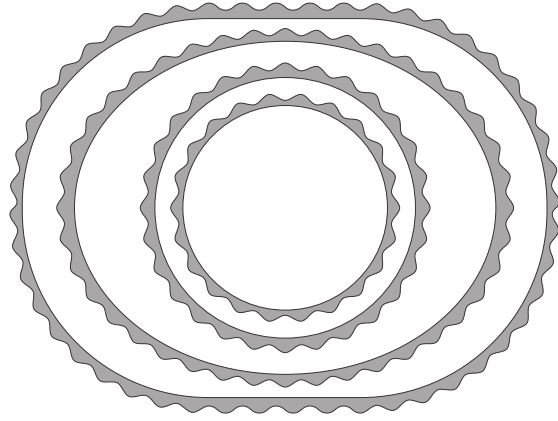

Turner Warwick Needleholder with Tungsten Carbide Jaws

Curved shanks with one short bow

| Code | Description |
|----------|-------------|
| Sb-5835 | 230mm long |
| Sb-5835A | 200mm long |

Blade A



| Code | Description |
|-------------|--------------------------|
| Sb-GI/522-A | Blade only - 19mm x 76mm |

Blade B

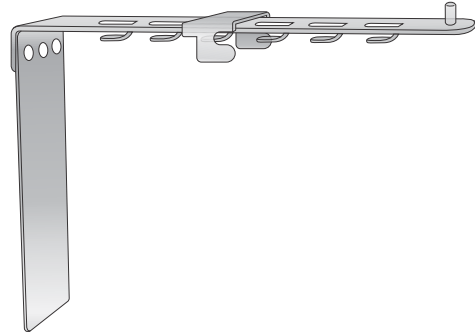

| Code | Description |
|-------------|---------------------------|
| Sb-GI/522-B | Blade only - 38mm x 102mm |

Blade C

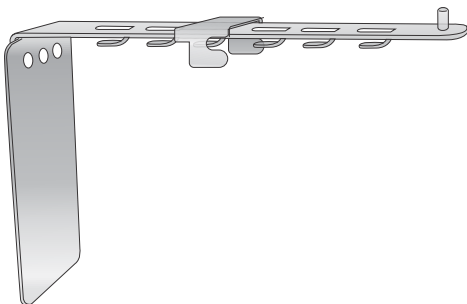

| Code | Description |
|-------------|--------------------------|
| Sb-GI/522-C | Blade only - 57mm x 89mm |

Blade D

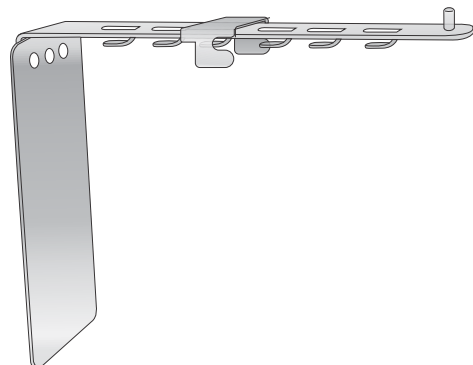

| Code | Description |
|-------------|---------------------------|
| Sb-GI/522-D | Blade only - 57mm x 114mm |



TURNER WARWICK RETRACTORS

STAHLÉAN BRAZIL
SAVING LIVES



Blade E

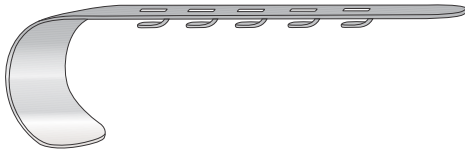

| Code | Description |
|-------------|---|
| Sb-GI/522-E | Blade only - curved stainless steel blade 51mm x 38mm |

Blade F

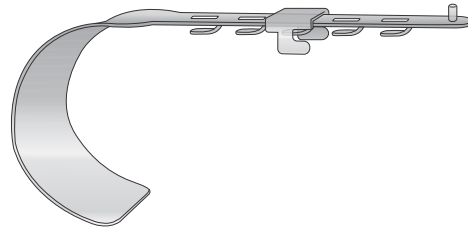

| Code | Description |
|-------------|---|
| Sb-GI/522-F | Blade only - curved stainless steel blade 76mm x 60mm |

Blade G

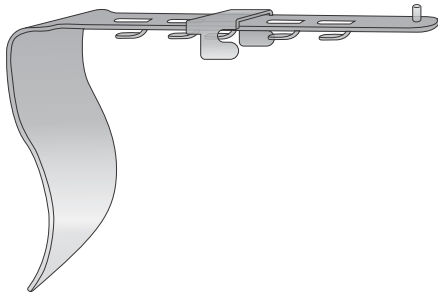

| Code | Description |
|-------------|---|
| Sb-GI/522-G | Blade only - flat stainless steel blade 89mm x 60mm |

Blade J



| Code | Description |
|-------------|-------------------------------------|
| Sb-GI/522-J | Blade only - single hook, 13mm deep |

Blade K

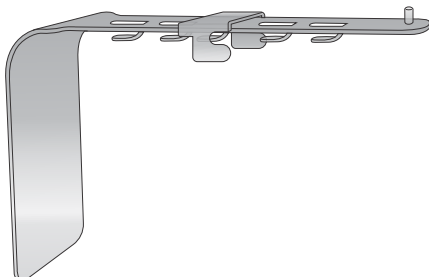

| Code | Description |
|----------------|---|
| Sb-SC-GI/522-K | Blade only - flat with clip 55mm x 90mm |

Blade L

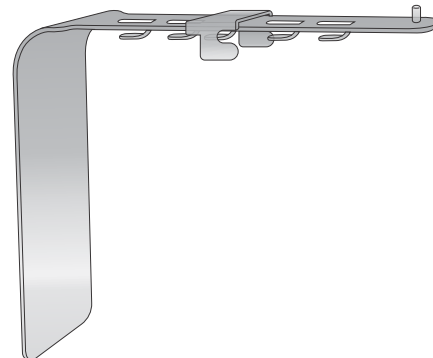

| Code | Description |
|-------------|--|
| Sb-GI/522-L | Blade only - flat with clip 55mm x 120mm |

RETRACTORS

STAHLÉAN BRAZIL
SAVING LIVES



Collin Retractor

110mm fully open, 235mm long

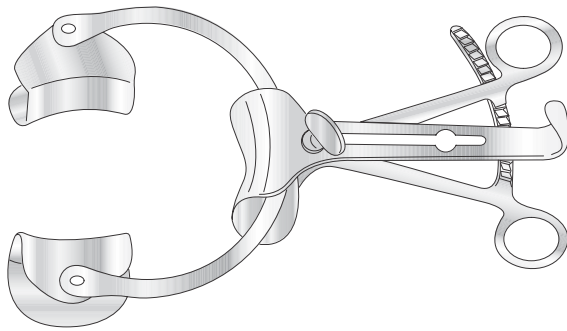

| Code | Description |
|------------|---|
| Sb-GI/322 | Complete with centre blade 55 x 40mm and one pair of blades 38mm x 60mm |
| Sb-GI/322a | Without centre blade |

Joll Thyroid Retractor

Self retaining, with lock-in nut

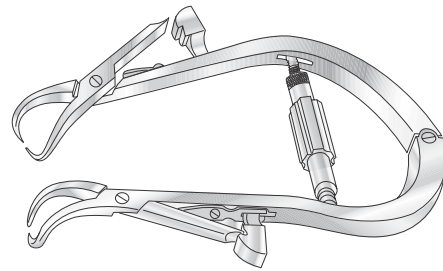

| Code | Description |
|-----------|-------------|
| Sb-GI/363 | 152mm long |

Gelpi Retractor

Self retaining

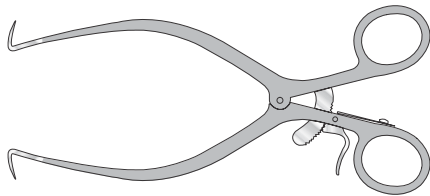

| Code | Description |
|------------|-------------|
| Sb-GY/013a | 140mm long |
| Sb-GY/013b | 178mm long |

Gossett Abdominal Retractor

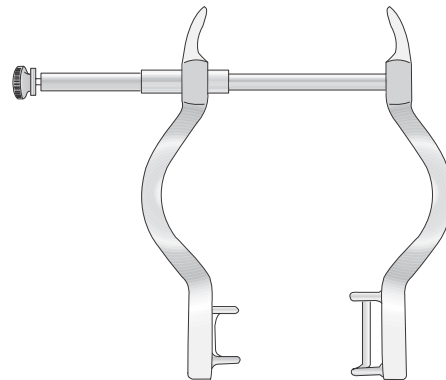

| Code | Description |
|-----------|------------------------------|
| Sb-GI/303 | Large, fully open 185mm long |
| Sb-GI/304 | Small, fully open 95mm long |

Pozzi Abdominal Retractors

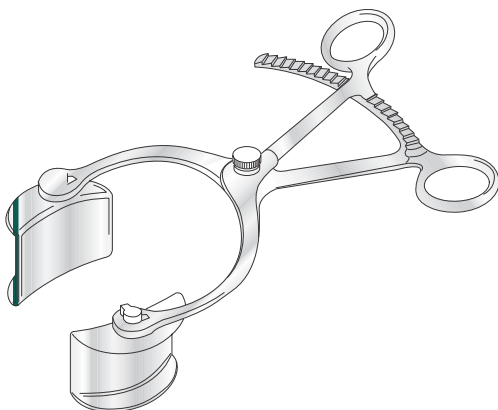

| Code | Description |
|-----------|---|
| Sb-GI/370 | Swivel blades: 38 x 60mm, bivalve, 254mm long |

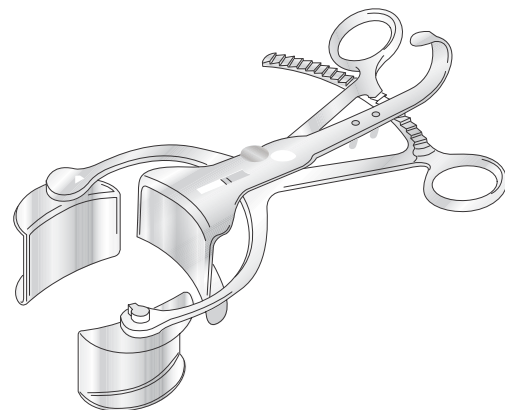

| Code | Description |
|-----------|--|
| Sb-GI/371 | Swivel blades: 38 x 59mm, trivalve, 203mm long |

RETRACTORS

STAHLÉAN BRAZIL
SAVING LIVES



Bowlby Dilator

Curved

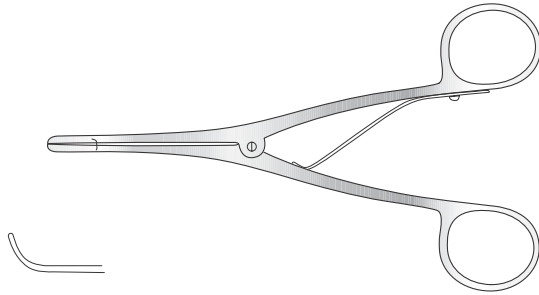

| Code | Description |
|-----------|-------------|
| Sb-GI/495 | 145mm long |

Travers Retractor

Self retaining with internal rack, 210mm long

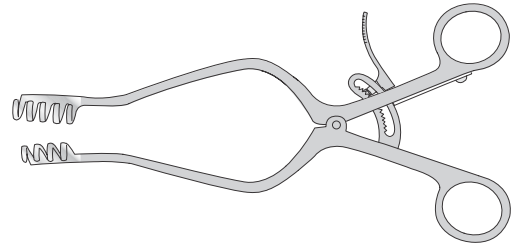

| Code | Description |
|-----------|------------------------------|
| Sb-GI/323 | 4 x 5 teeth, 95mm fully open |

Irwin Retractor

Self retaining, with cam rack, 4 x 4 teeth

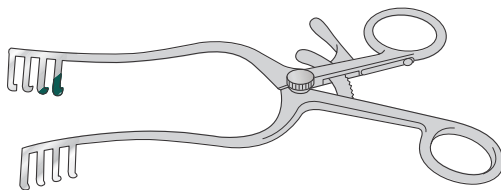

| Code | Description |
|-----------|-------------|
| Sb-GI/324 | 178mm long |

West Retractor

Self retaining, 140mm long

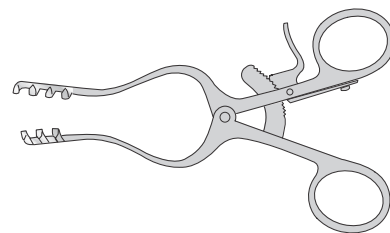

| Code | Description |
|-------------|---|
| Sb-GI/326 | 3 x 4 teeth, 60mm fully open |
| Sb-GI/326cr | 3 x 4 teeth, 60mm fully open, with cam rack |

Norfolk and Norwich Retractor

4 x 5 teeth 50mm blades x 223mm long

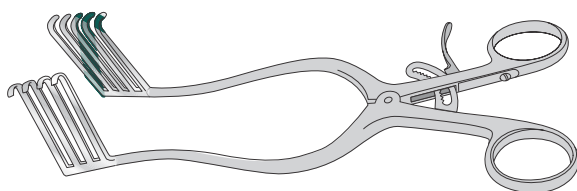

| Code | Description |
|-----------|---------------|
| Sb-GI/325 | Standard rack |

Weitlander Retractor

3-4 teeth

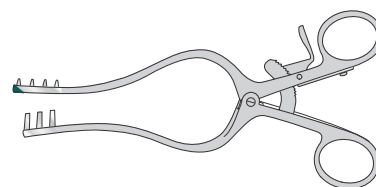

135mm long

| Code | Description |
|------------|------------------|
| Sb-GI/496 | Blunt |
| Sb-GI/496a | Sharp |
| Sb-GI/496b | Sharp, 2-3 teeth |
| Sb-GI/496c | Blunt, 2-3 teeth |

165mm long

| Code | Description |
|------------|-------------|
| Sb-GI/497 | Blunt |
| Sb-GI/497a | Sharp |

RETRACTORS

STAHLÉAN BRAZIL
SAVING LIVES



Kocher Retractor

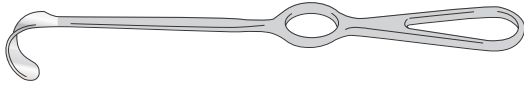

230mm long

| Code | Description |
|-----------|-----------------|
| Sb-GI/378 | 36 x 20mm blade |

250mm long

| Code | Description |
|------------|-----------------|
| Sb-GI/378a | 67 x 25mm blade |
| Sb-GI/378b | 80 x 42mm blade |
| Sb-GI/378c | 80 x 50mm blade |
| Sb-GI/378d | 80 x 60mm blade |

Canny Ryall Navy Retractor

Double-ended, with one single hook blade 5mm wide, and one fenestrated blade

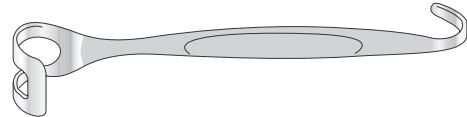

| Code | Description |
|------------|---|
| Sb-GI/343 | Fenestrated blade 16mm wide, 190mm long |
| Sb-GI/343a | Fenestrated blade 19mm wide, 190mm long |
| Sb-GI/343b | Fenestrated blade 25mm wide, 220mm long |
| Sb-GI/343c | Fenestrated blade 30mm wide, 220mm long |

Kocher Langenbeck Retractor

215mm long

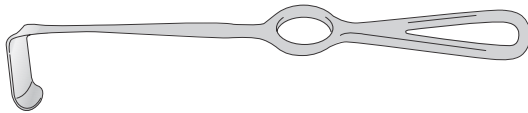

| Code | Description |
|-------------|-----------------|
| Sb-GI/336sp | 25 x 6mm blade |
| Sb-GI/379a | 35 x 8mm blade |
| Sb-GI/379b | 35 x 11mm blade |
| Sb-GI/379c | 35 x 15mm blade |
| Sb-GI/357sp | 41 x 11mm blade |

| Code | Description |
|-----------------|-----------------|
| Sb-THO/cutsp015 | 55 x 11mm blade |
| Sb-GI/379d | 70 x 15mm blade |
| Sb-GI/379e | 80 x 12mm blade |
| Sb-GI/379f | 80 x 16mm blade |

Canny Ryall Army Retractor

Double prong, 13mm wide, 165mm long



| Code | Description |
|------------|------------------|
| Sb-GI/342 | Large, 19mm wide |
| Sb-GI/342a | Small, 11mm wide |

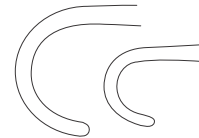

Langenbeck Retractor

Single ended



| Code | Description |
|-------------|-------------------|
| Sb-GI/336 | Blade 22mm x 6mm |
| Sb-GI/337 | Blade 45mm x 13mm |
| Sb-GI/337a | Blade 65mm x 13mm |
| Sb-GI/338a | Blade 75mm x 25mm |
| Sb-GI/338a1 | Blade 65mm x 25mm |

Czerny Retractor

Double ended

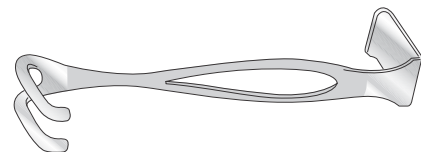

| Code | Description |
|-----------|-------------|
| Sb-GI/341 | 171mm long |

Landon Retractor

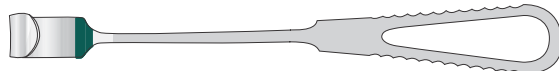

| Code | Description |
|-----------|-------------|
| Sb-GI/494 | 230mm |



Lane Retractor

Double ended blade, 229mm long

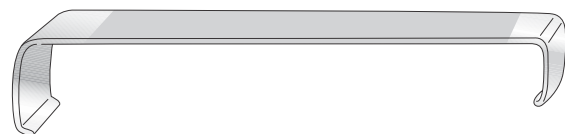

| Code | Description |
|-----------|------------------|
| Sb-GI/339 | 13mm x 19mm wide |
| Sb-GI/340 | 25mm x 32mm wide |

RETRACTORS

STAHLÉAN BRAZIL
SAVING LIVES



Kocher Retractor

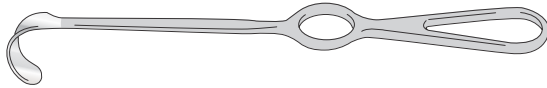

230mm long

| Code | Description |
|-----------|-----------------|
| Sb-GI/378 | 36 x 20mm blade |

250mm long

| Code | Description |
|------------|-----------------|
| Sb-GI/378a | 67 x 25mm blade |
| Sb-GI/378b | 80 x 42mm blade |
| Sb-GI/378c | 80 x 50mm blade |
| Sb-GI/378d | 80 x 60mm blade |

Canny Ryall Navy Retractor

Double-ended, with one single hook blade 5mm wide, and one fenestrated blade

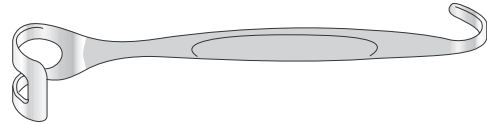

| Code | Description |
|------------|---|
| Sb-GI/343 | Fenestrated blade 16mm wide, 190mm long |
| Sb-GI/343a | Fenestrated blade 19mm wide, 190mm long |
| Sb-GI/343b | Fenestrated blade 25mm wide, 220mm long |
| Sb-GI/343c | Fenestrated blade 30mm wide, 220mm long |

Kocher Langenbeck Retractor

215mm long

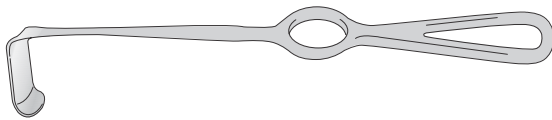

| Code | Description |
|-------------|-----------------|
| Sb-GI/336sp | 25 x 6mm blade |
| Sb-GI/379a | 35 x 8mm blade |
| Sb-GI/379b | 35 x 11mm blade |
| Sb-GI/379c | 35 x 15mm blade |
| Sb-GI/357sp | 41 x 11mm blade |

| Code | Description |
|-----------------|-----------------|
| Sb-THO/cutsp015 | 55 x 11mm blade |
| Sb-GI/379d | 70 x 15mm blade |
| Sb-GI/379e | 80 x 12mm blade |
| Sb-GI/379f | 80 x 16mm blade |

Canny Ryall Army Retractor

Double prong, 13mm wide, 165mm long



| Code | Description |
|------------|------------------|
| Sb-GI/342 | Large, 19mm wide |
| Sb-GI/342a | Small, 11mm wide |

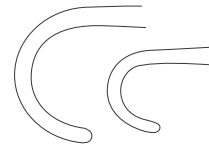

Langenbeck Retractor

Single ended



| Code | Description |
|-------------|-------------------|
| Sb-GI/336 | Blade 22mm x 6mm |
| Sb-GI/337 | Blade 45mm x 13mm |
| Sb-GI/337a | Blade 65mm x 13mm |
| Sb-GI/338a | Blade 75mm x 25mm |
| Sb-GI/338a1 | Blade 65mm x 25mm |

Czerny Retractor

Double ended

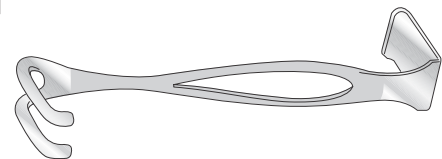

| Code | Description |
|-----------|-------------|
| Sb-GI/341 | 171mm long |

Landon Retractor

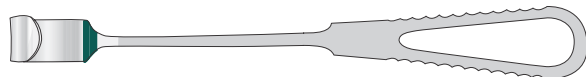

| Code | Description |
|-----------|-------------|
| Sb-GI/494 | 230mm |



Lane Retractor

Double ended blade, 229mm long

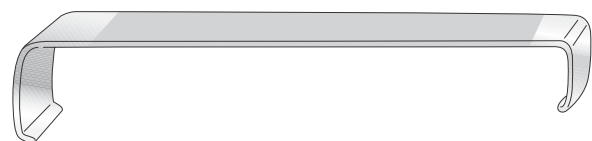

| Code | Description |
|-----------|------------------|
| Sb-GI/339 | 13mm x 19mm wide |
| Sb-GI/340 | 25mm x 32mm wide |

RETRACTORS

STAHLÉAN BRAZIL
SAVING LIVES



Morris Retractor

Single blade, 229mm long

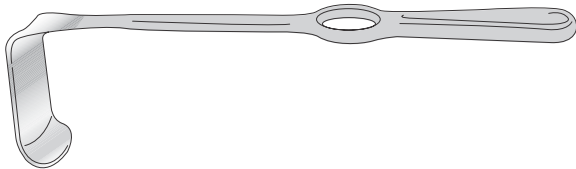

| Code | Description |
|-----------|-------------|
| Sb-GI/330 | 38 x 51mm |
| Sb-GI/331 | 51 x 51mm |
| Sb-GI/332 | 64 x 51mm |

Morris Retractor

Double ended, 216mm long

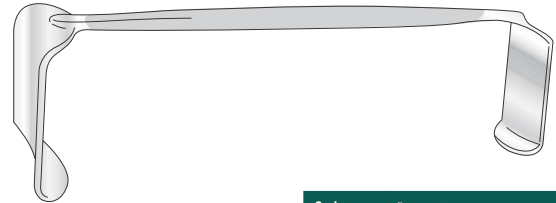

| Code | Description |
|-----------|-------------------------|
| Sb-GI/327 | 32 x 51mm and 38 x 51mm |
| Sb-GI/328 | 44 x 51mm and 51 x 51mm |
| Sb-GI/329 | 64 x 51mm and 38 x 51mm |

Moynihan Retractor

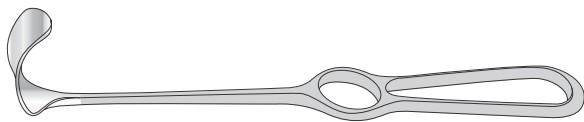

| Code | Description |
|-----------|---|
| Sb-GI/462 | Single ended, blade 13 x 22mm, 215mm long |

Deaver Abdominal Retractors



| Code | Description |
|-----------|--------------------------------|
| Sb-GI/306 | Set of 5, 315mm overall length |
| Sb-GI/307 | 25mm wide |
| Sb-GI/308 | 25mm wide |
| Sb-GI/309 | 38mm wide |
| Sb-GI/310 | 51mm wide |
| Sb-GI/311 | 76mm wide |

Elliot (Modified Deaver) Retractor

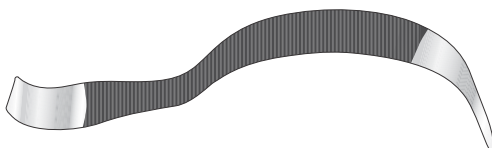

| Code | Description |
|------------|------------------|
| Sb-GI/308M | With flat handle |

Dyball and Lock Retractor

For liver

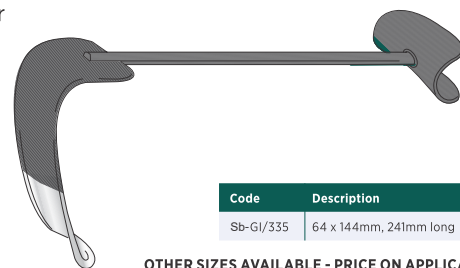

| Code | Description |
|-----------|------------------------|
| Sb-GI/335 | 64 x 144mm, 241mm long |

OTHER SIZES AVAILABLE - PRICE ON APPLICATION

Deaver Abdominal Retractors

With round handles

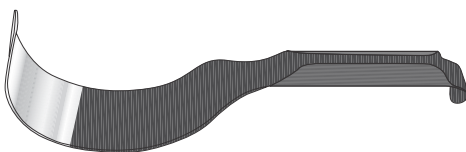

| Code | Description |
|-----------|--------------------------------|
| Sb-GI/312 | Set of 5, 305mm overall length |
| Sb-GI/313 | 25mm wide |
| Sb-GI/314 | 25mm wide |
| Sb-GI/315 | 38mm wide |
| Sb-GI/316 | 51mm wide |
| Sb-GI/317 | 76mm wide |

Kelly Retractor Blade

267mm long



| Code | Description |
|-----------|-------------|
| Sb-GI/333 | 38 x 191mm |
| Sb-GI/334 | 57 x 191mm |

RETRACTORS

STAHLÉAN BRAZIL
SAVING LIVES



Durham Retractor

With fenestrated blade, 216mm long

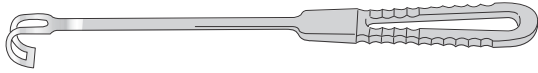

| Code | Description |
|-----------|-------------|
| Sb-GI/300 | 10mm wide |
| Sb-GI/301 | 14mm wide |
| Sb-GI/302 | 20mm wide |

Ballance (Volkman) Retractor

203mm long

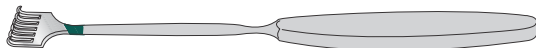

Sharp

| Code | Description |
|------------|-------------|
| Sb-GI/463 | 1 prong |
| Sb-GI/463a | 2 prong |
| Sb-GI/463b | 3 prong |
| Sb-GI/463c | 4 prong |
| Sb-GI/463d | 6 prong |

Blunt

| Code | Description |
|------------|-------------|
| Sb-GI/463e | 1 prong |
| Sb-GI/463f | 2 prong |
| Sb-GI/463g | 3 prong |
| Sb-GI/463h | 4 prong |
| Sb-GI/463i | 6 prong |

Volkman Retractor



| Code | Description |
|------------|-------------------|
| Sb-OR/400 | Sharp, 220mm long |
| Sb-OR/400a | Blunt, 220mm long |
| Sb-OR/400b | Sharp, 245mm long |

Kilner Retractor

Double ended, cat's paw

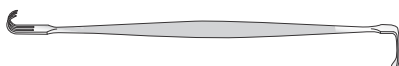

| Code | Description |
|-----------|-------------|
| Sb-PL/056 | 152mm long |

Kocher Retractor

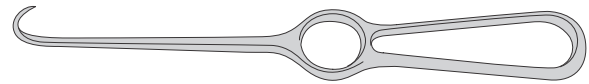

| Code | Description |
|-------------|-------------------|
| Sb-OR/N036c | Sharp, 205mm long |
| Sb-OR/N036 | Sharp, 220mm long |
| Sb-OR/N036b | Blunt, 220mm long |

Senn-Miller Retractor

170mm long



| Code |
|------------|
| Sb-SH/5881 |

Single Hook Retractor

Sharp



| Code | Description |
|--------------|-----------------|
| Sb-GI/SH5671 | 152mm long |
| Sb-PL/065b | Half size, fine |

Gillies Skin Hook

Solid handle, 190mm long



| Code | Description |
|------------|-----------------|
| Sb-PL/065a | Standard, fine |
| Sb-PL/065b | Half size, fine |

DISSECTORS AND PROBES

STAHLÉAN BRAZIL
SAVING LIVES



MacDonald Dissector Double Ended



| Code | Description |
|-----------|-------------|
| Sb-GI/285 | 191mm long |

Probe, Sinus Silver



| Code | Description |
|-----------|-------------|
| Sb-GI/464 | 152mm long |

Brodie Director Probe Ended, Silver Plated



| Code | Description |
|-----------|-------------|
| Sb-GI/286 | 165mm long |

Probe, Fish Tail Silver Plated



| Code | Description |
|-----------|-------------|
| Sb-GI/293 | 127mm long |
| Sb-GI/294 | 152mm long |
| Sb-GI/295 | 203mm long |
| Sb-GI/296 | 254mm long |

Watson Cheyne Dissector

Fine, double-ended, with probe end



| Code | Description |
|------------|-------------|
| Sb-GI/287 | 127mm long |
| Sb-GI/288 | 191mm long |
| Sb-GI/288a | 230mm long |
| Sb-GI/288b | 255mm long |

Jobson Horne Probe Dressing (Aural)

With one flat tapered end, serrated edge and one small ring end, stainless steel



| Code | Description |
|-----------|-------------|
| Sb-GI/297 | 140mm long |
| Sb-GI/298 | 178mm long |

Probe, Malleable Silver Plated



| Code | Description |
|------------|-------------|
| Sb-GI/289a | 127mm long |
| Sb-GI/289 | 152mm long |
| Sb-GI/290 | 178mm long |
| Sb-GI/291 | 203mm long |
| Sb-GI/292 | 255mm long |
| Sb-GI/292a | 305mm long |

Stahleanbrazil

A table-fixed retractor system designed by surgeons to efficiently and reliably hold surgical instruments in place during surgery while allowing greater visibility.

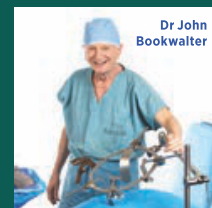

Table Post and Coupling, Horizontal Flex Bar, Segmented Rings, Tilt Ratchet Mechanism, Kelly Retractors, Blades and Ratchets

MISCELLANEOUS

STAHLÉAN BRAZIL
SAVING LIVES



Aneurysm Needle

Small, for infusions



| Code | Description |
|------------|-------------|
| Sb-GI/472a | 146mm long |

Syme Aneurysm Needle

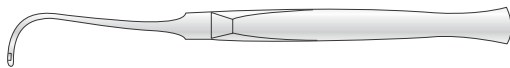

| Code | Description |
|-----------|-------------|
| Sb-GI/473 | 165mm long |

Ring Cutter

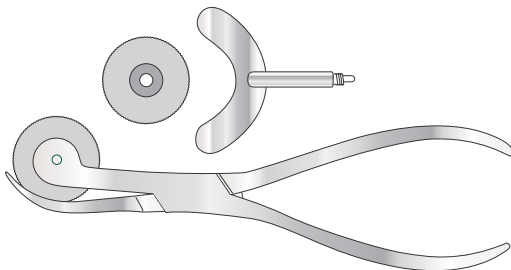

| Code | Description |
|------------|--------------------------------|
| Sb-GI/452 | Circular saw blade, 165mm long |
| Sb-GI/452a | Spare blade |

Mayo Instrument Pin

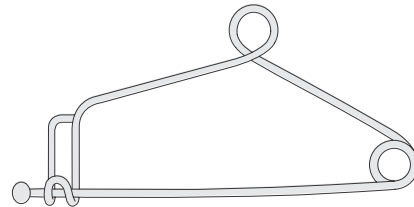

| Code | Description |
|-----------|-------------|
| Sb-GI/355 | 102mm long |
| Sb-GI/356 | 152mm long |

Baron Scalpel Handle

130mm long



| Code | Description |
|-----------|-------------|
| Sb-PM/003 | No 3 |
| Sb-PM/004 | No 4 |

Scalpel Handle

127mm long



| Code | Description |
|------------|-------------|
| Sb-PM/007 | No 3 |
| Sb-PM/008 | No 4 |
| Sb-PM/008a | No 4 L |
| Sb-PM/001a | No 7 |

Endoscope Re-fibre

Stahleánbrazil manufacture their own fibre bundles in house. We cover small and larger diameter scopes and only use high quality German fibre optic material and stainless steel tubing.

- Quality components, globally sourced:
- ✓ Medical grade stainless steel tubing
 - ✓ German engineered new glass fibre
 - ✓ New fibre cone as standard
 - ✓ New solderable sapphire distal window
 - ✓ New light post colour ring
 - ✓ New objective in 95% of cases
 - ✓ Replacement 'O' ring to prevent leakage

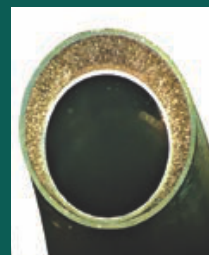

After repair



Before repair

HOLLOW WARE

STAHLÉAN BRAZIL
SAVING LIVES



Kidney Dish

Stainless steel

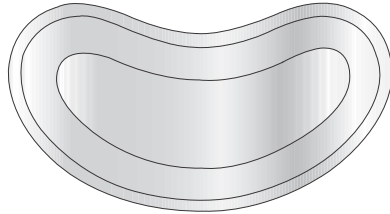

| Code | Description |
|-----------|-------------|
| Sb-GI/380 | 152mm |
| Sb-GI/381 | 203mm |
| Sb-GI/382 | 254mm |
| Sb-GI/383 | 305mm |

Cheate Jar

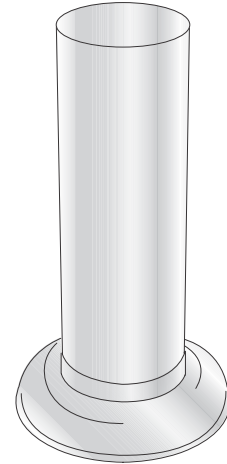

| Code | Description |
|-----------|-------------------------------|
| Sb-GI/397 | Stainless steel, 203mm x 50mm |

Lotion Bowl

Without lid, stainless steel

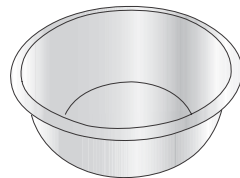

| Code | Description |
|-----------|-------------|
| Sb-GI/384 | 102mm |
| Sb-GI/385 | 152mm |
| Sb-GI/386 | 203mm |
| Sb-GI/387 | 254mm |
| Sb-GI/388 | 305mm |

Measuring Jug



| Code | Description |
|-----------|------------------|
| Sb-GI/395 | 1 litre capacity |

Instrument Tray

Stainless steel

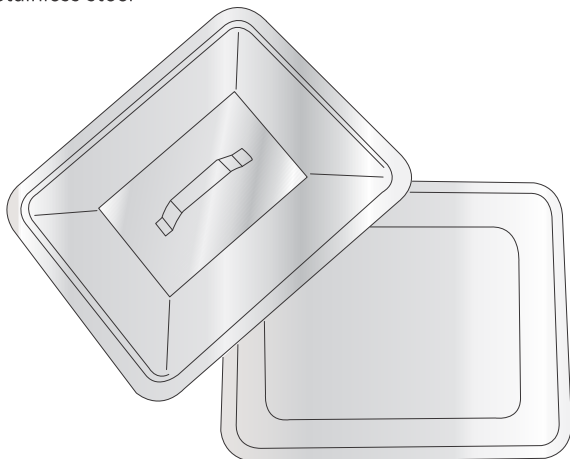

| Code | Description |
|-----------|-------------------------------|
| Sb-GI/389 | 254 x 203 x 50mm |
| Sb-GI/390 | Lid only for 254 x 203 x 50mm |
| Sb-GI/391 | 305 x 254 x 50mm |
| Sb-GI/392 | Lid only for 305 x 254 x 50mm |
| Sb-GI/393 | 356 x 305 x 50mm |
| Sb-GI/394 | Lid only for 356 x 305 x 50mm |

Petri Dish



| Code | Description |
|--------------|----------------------------------|
| Sb-SH/002149 | 100mm, stainless steel, with lid |

Gallipot

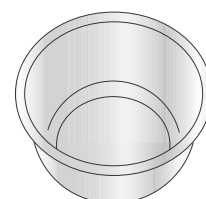

| Code | Description |
|-----------|-----------------------|
| Sb-GI/396 | Stainless steel, 63mm |

SILICONE MATTING & STERILISING BASKETS

STAHLÉAN BRAZIL
SAVING LIVES



Silicone Matting

Medical grade for storage, sterilisation and transportation of instruments.

Cushion, protect, and organise delicate surgical instruments during storage, transportation, and sterilisation. Perforations allow for ventilation during the sterilisation process. The silicone mat can be cut to fit any size container.

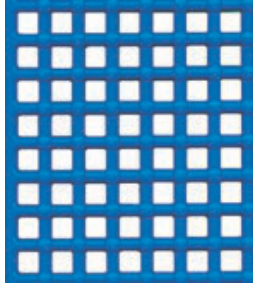

502mm long x 242mm wide
7mm holes, 10mm between holes

| Code |
|----------|
| SI/1004M |

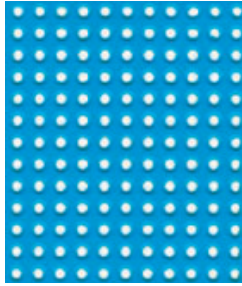

515mm long x 240mm wide
3mm holes, 6mm between holes

| Code |
|----------|
| SI/1001M |

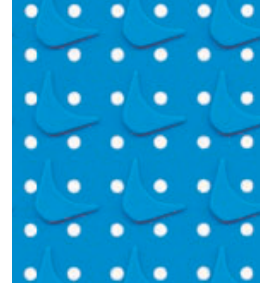

570mm long x 550mm wide
4mm holes, 13mm between holes

| Code |
|----------|
| SI/1002M |

Sterilising Baskets

DIN Basket

Wire mesh base with perforated sides and two carrying handles

| Code | Description |
|-------------|------------------|
| Sb-GI/CO006 | 230 x 130 x 60mm |
| Sb-GI/CO007 | 240 x 130 x 50mm |
| Sb-GI/CO008 | 240 x 130 x 60mm |
| Sb-GI/CO009 | 240 x 250 x 50mm |
| Sb-GI/CO010 | 240 x 250 x 60mm |
| Sb-GI/CO014 | 300 x 300 x 50mm |
| Sb-GI/CO015 | 350 x 350 x 60mm |
| Sb-GI/CO011 | 480 x 250 x 50mm |
| Sb-GI/CO012 | 480 x 250 x 60mm |

| Code | Description |
|-------------|------------------|
| Sb-GI/CO013 | 480 x 250 x 70mm |
| Sb-GI/CO016 | 480 x 400 x 60mm |
| Sb-GI/CO017 | 480 x 480 x 50mm |
| Sb-GI/CO018 | 480 x 480 x 60mm |
| Sb-GI/CO019 | 500 x 300 x 50mm |
| Sb-GI/CO020 | 550 x 430 x 50mm |
| Sb-GI/CO021 | 600 x 300 x 60mm |



DIN Basket

Wire mesh basket with two carrying handles

| Code | Description |
|-------------|------------------|
| Sb-GI/CO022 | 240 x 250 x 50mm |
| Sb-GI/CO023 | 240 x 250 x 60mm |
| Sb-GI/CO024 | 240 x 250 x 70mm |
| Sb-GI/CO031 | 300 x 300 x 60mm |
| Sb-GI/CO025 | 480 x 250 x 50mm |

| Code | Description |
|-------------|-------------------|
| Sb-GI/CO026 | 480 x 250 x 60mm |
| Sb-GI/CO027 | 480 x 250 x 70mm |
| Sb-GI/CO028 | 480 x 250 x 100mm |
| Sb-GI/CO029 | 480 x 480 x 50mm |
| Sb-GI/CO030 | 480 x 480 x 70mm |

DIN Basket Lids

For perforated and wire mesh baskets

| Code | Description |
|-------------|-------------|
| Sb-GI/CO032 | 240 x 250mm |
| Sb-GI/CO033 | 300 x 300mm |
| Sb-GI/CO034 | 480 x 250mm |
| Sb-GI/CO035 | 480 x 480mm |

Did you know...

Organising and fixing instruments in place can aid the cleaning process.

Help keep your instruments in good condition for longer with our baskets and trays. Available in custom sizes, to suit your requirements perfectly.

STERILISING BASKETS

STAHLÉAN BRAZIL
SAVING LIVES



ENT Basket

Wire mesh base with perforated sides and two carrying handles, supplied with lid

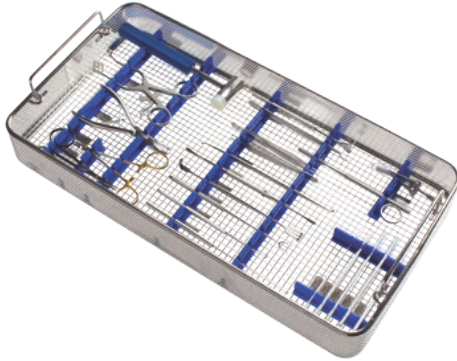

| Code | Description |
|-------------|-------------------|
| Sb-GI/CO036 | 480 x 250 x 160mm |
| Sb-GI/CO037 | Fixing clamps |

Arthroscope Basket

Wire mesh base with two fixing clamps

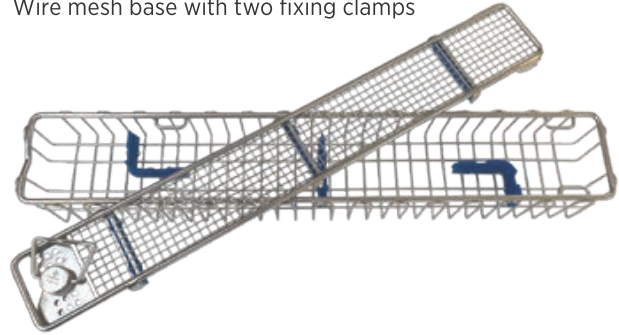

| Code | Description |
|-------------|-----------------|
| Sb-GI/CO001 | 290 x 80 x 52mm |

Endoscope Basket

With small lens basket

| Code | Description |
|-------------|-------------------|
| Sb-GI/CO002 | 6400 x 150 x 77mm |

Wire mesh base with two fixing clamps

| Code | Description |
|-------------|---------------------|
| Sb-GI/CO003 | S - 460 x 80 x 52mm |
| Sb-GI/CO004 | D - 480 x 80 x 52mm |
| Sb-GI/CO005 | D - 680 x 80 x 52mm |

Sieve

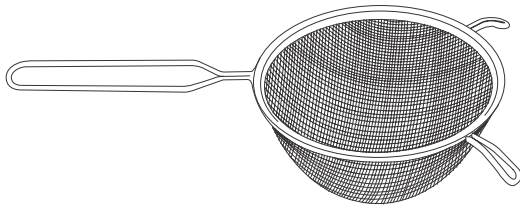

| Code | Description |
|------------|----------------|
| Sb-GI/5071 | 203mm x 50mm ø |

Fine Mesh Basket



With hinged take off / lockable lid

| Code | Description |
|-------------|------------------|
| Sb-GI/CO041 | 120 x 155 x 40mm |
| Sb-GI/CO044 | 120 x 155 x 50mm |
| Sb-GI/CO042 | 235 x 155 x 40mm |
| Sb-GI/CO045 | 235 x 155 x 50mm |
| Sb-GI/CO043 | 375 x 260 x 40mm |

With separate lid

| Code | Description |
|-------------|------------------|
| Sb-GI/CO038 | 120 x 155 x 40mm |
| Sb-GI/CO039 | 235 x 155 x 40mm |
| Sb-GI/CO040 | 375 x 260 x 40mm |

Stahleanbrazil Quadlock Containers



Stahleanbrazil offer the unique Quadlock container. The Patented design offers 4 locks, as opposed to the traditional 2, to ensure extra security and peace of mind.

OPTICAL FIBRE CABLES

STAHLÉAN BRAZIL
SAVING LIVES

Our optical fibre cables are compatible with all major scopes and illuminators. Every light lead is high temperature xenon compatible, rated to the highest level of thermal resistance and tested to ensure the highest light output possible.



Choice of 10 colours for easy identification



Choice of lengths and sheathing types

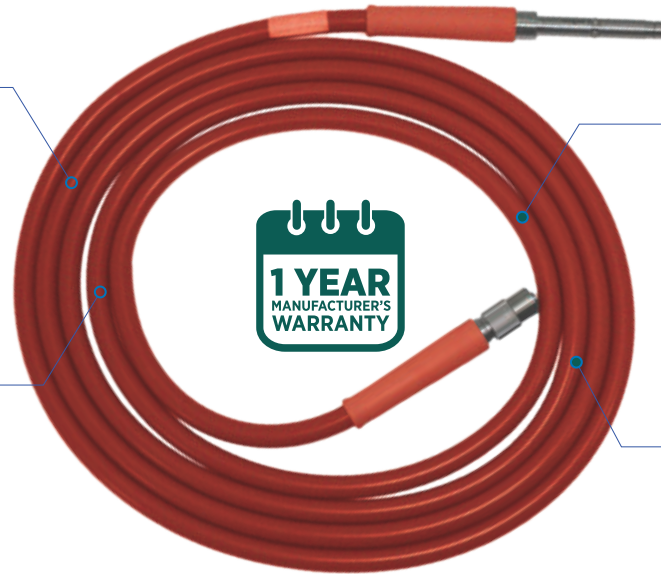

Free on-site light lead testing

We'll come and go through your lead stock to ensure your leads are fit for use



Reinforced for longer life

How to order

Select an option from each of the following steps to create your part number.

Part number = _____
Step 1 Step 2 Step 3 Step 4 Step 5 Step 6 Step 7

Example: 474810180FRGY is a Storz Proximal, Storz Distal, 4.8mm Bundle, 254mm Length, Fully Reinforced Sheathing in Grey

Step 1: Proximal

All end tips are stainless steel

ACMI



Ø 0.299

1

Wolf/Dyonics

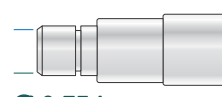

Ø 0.354

2

Long Wolf



Ø 0.354

L2

Olympus/ACMI

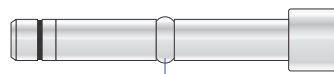

Retaining ring

3

Storz



4

Pilling

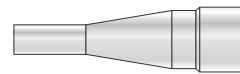

5

Universal



3/8-24 or 5/16-24 thread

U

OPTICAL FIBRE CABLES

STAHLÉAN BRAZIL
SAVING LIVES



Step 2: Distal

All end tips are stainless steel

Wolf Snap On

6



Storz

7

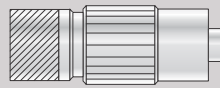

ACMI Snap-On

8

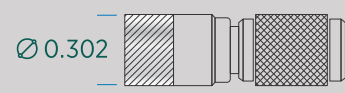

Olympus

9

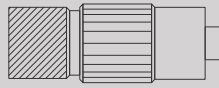

Wolf Clip-On

10

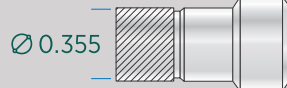

Pilling

11

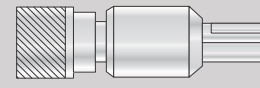

ACMI Clip-On

12

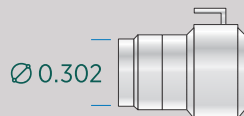

Mini Olympus

13

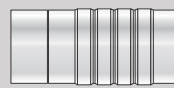

2.8 mm & 4.25 mm only

Universal

U

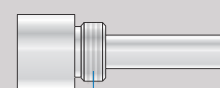

3/8-24 or 5/16-24 thread

Step 3: Bundle Size

Place gauge on bundle to determine diameter

2.2mm

22



2.8mm

28



Mini Olympus only

3.0mm

30



3.8mm

38



4.25mm

425



Mini Olympus only

4.8mm

48

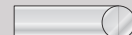

Step 4: Length

6ft

6

8ft

8

10ft

10

Call us for custom lengths

Step 5: Connector Angle

180°

180

45°

45

90°

90

Step 6: Sheathing Type

Non-reinforced

0

6" Reinforced*

6

Fully Reinforced*

FR

*Reinforced options are not available with clear sheathing

Step 7: Sheathing Colour

Black



BK

Blue



BL

Clear



CL

Green



GR

Gray



GY

Red



RD

Pink

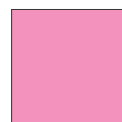

PK

White

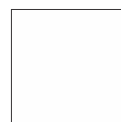

WH

Yellow



YL

4.8mm only



STAHLÉAN BRAZIL

SAVING LIVES

CONTACT US

Office in são paulo

 +5511972111007

 +5511933211007

 +923347711007

 @stahleanbrazil

 info@stahleanbrazil.com

 www.stahleanbrazil.com