

STAHLÉAN BRAZIL
SAVING LIVES



Ophthalmic Instruments



www.stahleanbrazil.com

Orthopaedic

Bone Cutting Forceps	3
Bone Rongeurs	5
Bone Holding Forceps	7
Plaster Spreaders and Shears	10
Bone Curettes	11
Bone Levers	16
Retractors	17
Raspatories, Burr and Rugines	20
Osteotomes, Chisels and Gouges	21
Wire Cutters and Pliers	24
Accessories	26
Mallets	27
Raspatories, Files and Punches	29
Pushers, Impactors and Skids	30
Elevators	31
Retractors and Bone Levers	33
Saws, Shears and Knives	34
Pins	35
Sterile Kirschner and Arthrodesis Wires	36
Extremities Instruments and Sets	37
Shoulder Instruments	38

Bone Cutting Forceps

McIndoe Bone Cutting Forcep

Lightweight, compound action, angled jaw with prismatic points

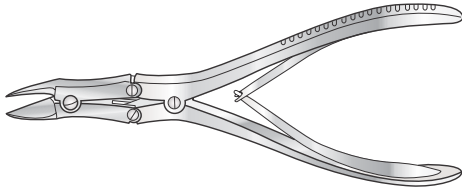

Code	Description
SB-OR/13b	165mm long
SB-OR/13c	191mm long

Liston Box Joint Bone Cutting Forcep

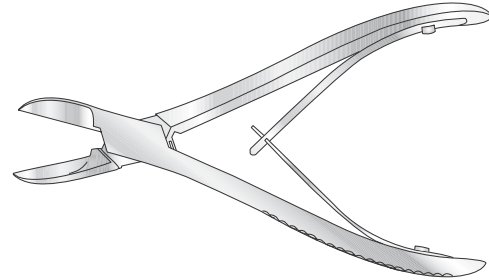

Code	Description
SB-OR/032	140mm long
SB-OR/033	200mm long
SB-OR/027	220mm long

Code	Description
SB-OR/061	170mm long
SB-OR/062	220mm long

Liston Screw Joint Bone Cutting Forcep

With fluted handle

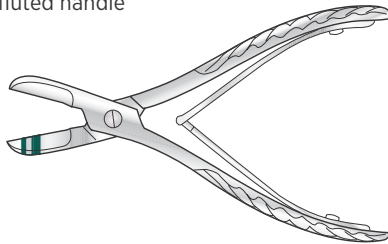

Code	Description
SB-OR/24	Straight
SB-OR/24a	Angled

Code	Description
SB-OR/26	Straight

Code	Description
SB-OR/25	Straight
SB-OR/25a	Angled

Code	Description
SB-OR/27	Straight

Screw Joint Bone Cutting Forcep

Straight

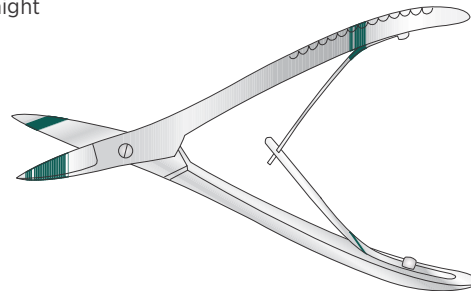

Code	Description
SB-OR/030	160mm long

Liston Compound Action Bone Cutting Forcep

Straight, for heavy duty

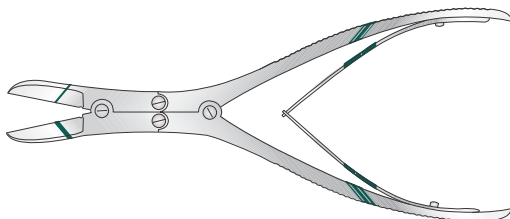

Code	Description
SBOR/27a	305mm long
SB-OR/27b	300mm long
SB-OR/27c	190mm long

Ruskin-Liston Bone Cutting Forcep

Compound action, fine

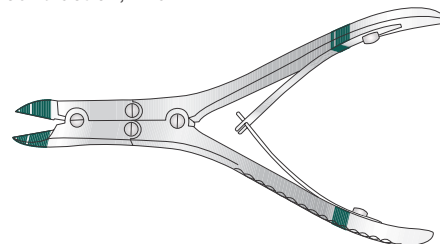

Code	Description
SB-OR/057	140mm long
SB-OR/074	145mm long
SB-OR/073	190mm long

Code	Description
SB-OR/063	190mm long

Bone Cutting Forceps and Bone Rongeurs

Ward Bone Cutting Forceps

Slightly angled on flat

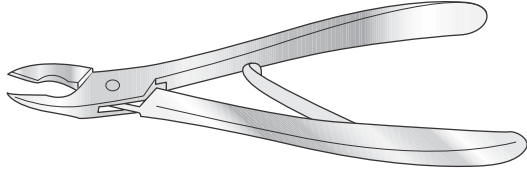

Code	Description
SB-GI/459	180mm long

Kleinert Kutz Bone Rongeur

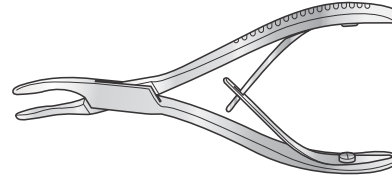

Code	Description
SB-OR/009a	Curved, 140mm, width 2mm
SB-OR/009	Curved, 155mm, width 2mm
SB-OR/011	Curved, 155mm, width 3mm

Horsley Compound Action

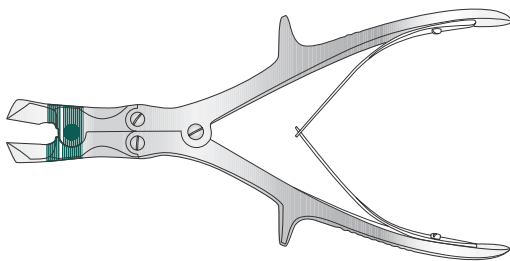

Code	Description
SB-OR/002	235mm long

Kleinert Kutz Skin Hooks



Code	Description
SB-PL/109	16cm large
SB-PL/108	16cm medium
SB-PL/107	16cm small

Standard, stainless steel

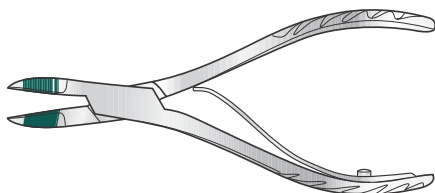

Code	Description
SB-OR/N056	140mm long

Did you know...

We repair power tools,
pneumatic tools and hoses



- 4 Stryker, Synthes, Hall, Microaire, De Soutter, and all other common brands repaired
- 4 All dental tools can be repaired, including bearings and rotor replacement
- 4 We also repair Phaco Handpieces and Ultrasound Handpieces

www.stahleanbrazil.com

Bone Rongeurs

Bone Rongeur

Straight, with or without horn, 230mm long

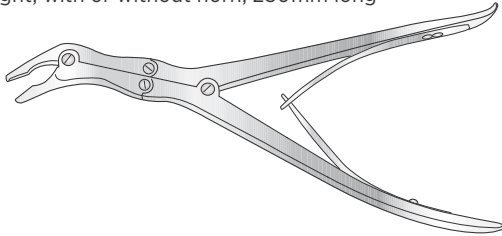

Code	Description
SB-OR/005	Width 2mm
SB-OR/006	Width 3mm
SB-OR/007	Width 4mm

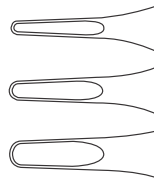

Stille Compound Action Bone Rongeur

Angled to side, 240mm long

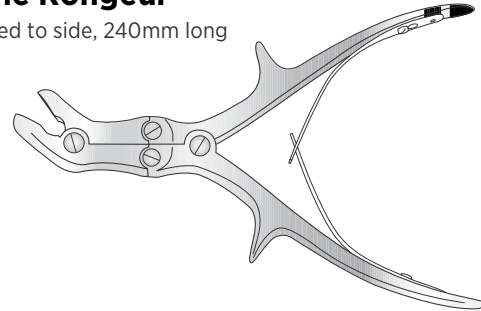

Code	Description
SB-OR/037	1mm bite

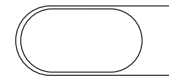

Leksell Compound Action Bone Rongeur

250mm long

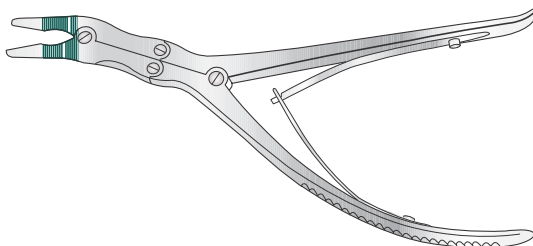

Code	Description
SB-OR/066	3mm bite
SB-OR/069	5mm bite
SBOR/065	8mm bite

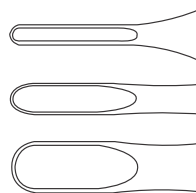

Leksell Stille Compound Action Bone Rongeur

240mm long

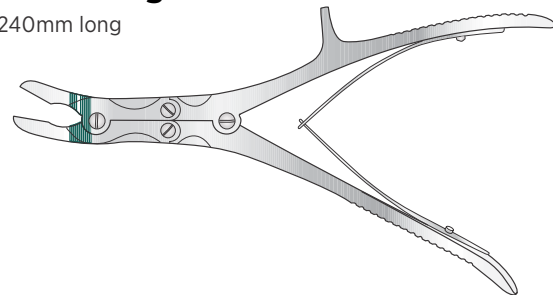

Code	Description
SB-OR/065a	8mm bite



Leksell Compound Action Bone Rongeur

240mm long

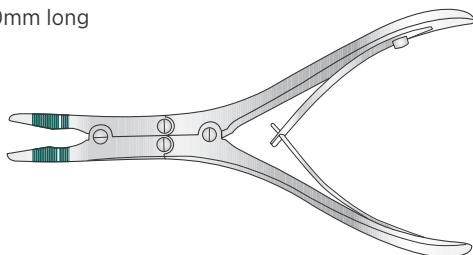

Code	Description
SB-OR/008	Width 3mm



Luer Stille Compound Action Bone Rongeur

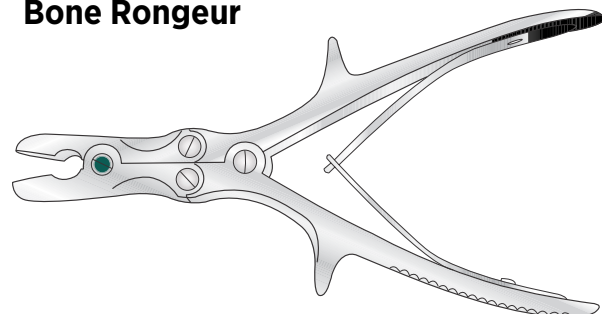

Code	Description
SBOR/071	10mm bite, 220mm long
SB-OR/072	12mm bite, 260mm long



Code	Description
SB-OR/071a	10mm bite, 220mm long
SBOR/071b	11mm bite, 230mm long

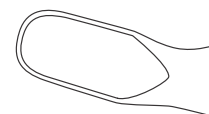

Bone Rongeurs

Luer Compound Action Bone Rongeur

6mm bite, 190mm long

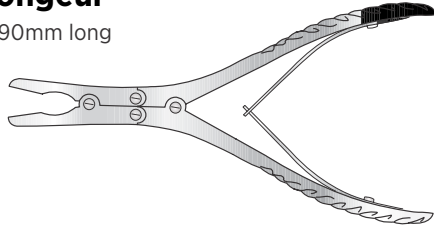

Code	Description
SB-OR/13	Straight
SB-OR/13a	Curved

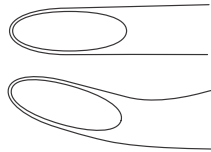

Ruskin Compound Action Bone Rongeur

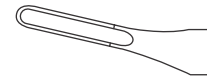
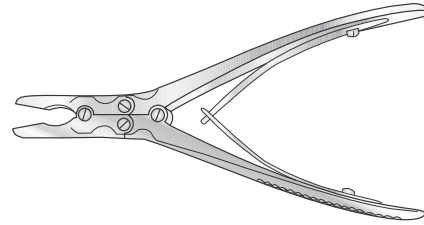

Code	Description
SB-OR/034	Straight
SB-OR/035	Curved

Code	Description
SB-OR/028	Straight
SB-OR/036	Curved

Luer Box Joint Bone Rongeur

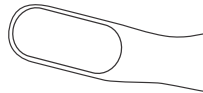
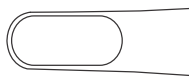
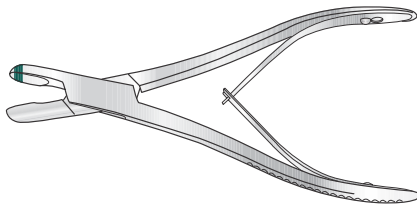

Code	Description
SB-OR/031	8mm bite
SB-OR/041	10mm bite

Code	Description
SB-OR/042	8mm bite

Compound Action Bone Rongeur

Lightweight pattern, curved, 150mm long

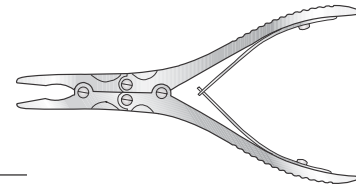

Code	Description
SBOR/013d	4mm bite

Cushing Screw Joint Bone Rongeur

190mm long

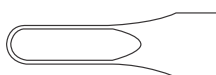
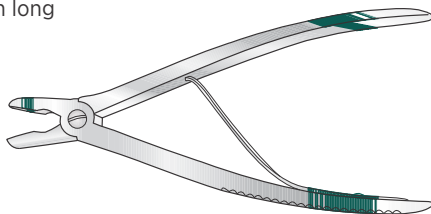

Code	Description
SB-OR/039	4mm bite
SB-OR/058	6mm bite
SB-OR/059	8mm bite

Code	Description
SB-OR/060	4mm bite
SB-OR/067	6mm bite
SBOR/068	8mm bite

Lempert Box Joint Bone Rongeur

3mm bite, 155mm long

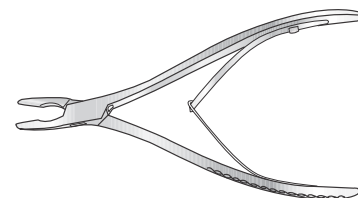

Code	Description
SB-OR/327	Straight
SB-OR/010	Curved

Bone Holding Forceps

Lambotte Bone Holding Forceps

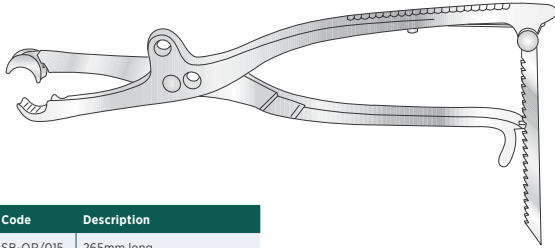

Code	Description
SB-OR/015	265mm long

Bone Holding Forceps

Screw joint, with holding screw

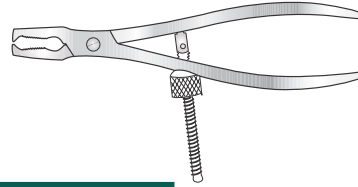

Code	Description
SB-OR/029	165mm long

Lambotte Bone Holding Forceps

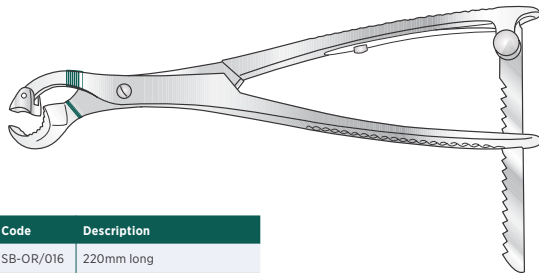

Code	Description
SB-OR/016	220mm long
SB-OR/017	215mm long
SB-OR/022	330mm long

Hey Groves Bone Holding Forceps

With screw locking device

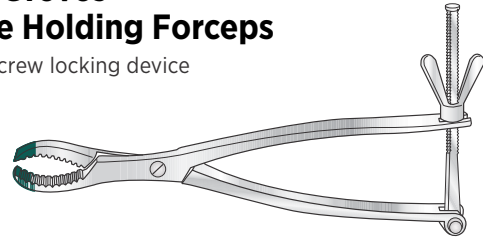

Code	Description
SB-OR/29d	200mm long
SB-OR/29e	225mm long
SB-OR/29f	305mm long

Farabeuf Bone Holding Forceps

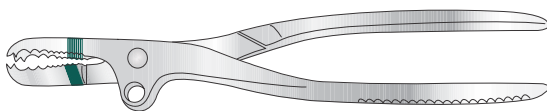

Code	Description
SB-OR/021	230mm long
SB-OR/328	250mm long

Bone Holding Forceps

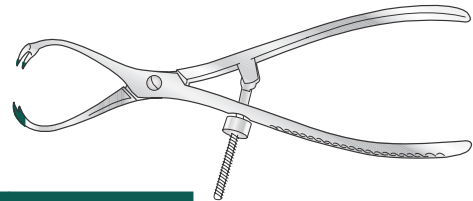

Code	Description
SB-OR/13	140mm long
SB-OR/014	185mm long
SB-OR/018	215mm long

Farabeuf-Lambotte Bone Holding Forceps

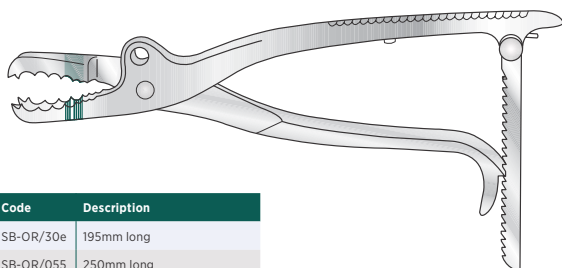

Code	Description
SB-OR/30e	195mm long
SB-OR/055	250mm long
SB-OR/30f	260mm long

Fergusson Bone Holding Forceps

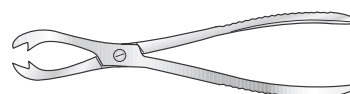

Code	Description
SB-OR/30	150mm long
SB-OR/30a	200mm long
SB-OR/30b	230mm long

Bone Holding Forceps

Sequestrum (Necrosis) Forcep

Straight, long fine jaws

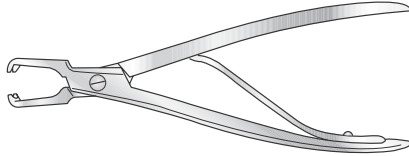

Code	Description
SB-OR/N061	180mm long

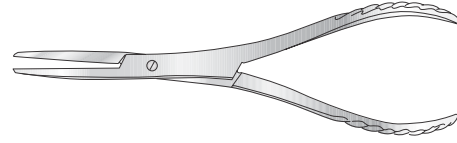

Code	Description
SB-OR/SEQ001	191mm long
SB-OR/SEQ002	203mm long

Joint Calcaneal Spreader

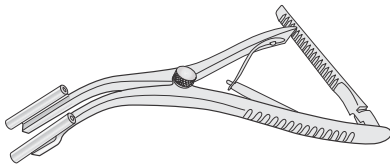

Code	Description
SB-OR/CAL001	40mm opening, 1.6mm ø, 170mm long

Calcaneal Spreader

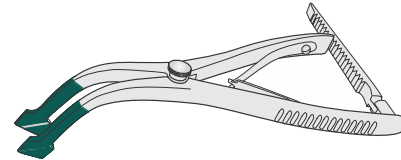

Code	Description
SBOR/CAL002	40mm opening, 15mm wide tip, 70mm long

Inge Type Lamina Spreader

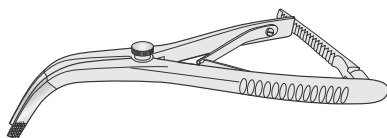

Code	Description
SB-OR/CAL003	40mm opening, no teeth, 5mm wide tip, 170mm long

Inge Type Lamina Spreader

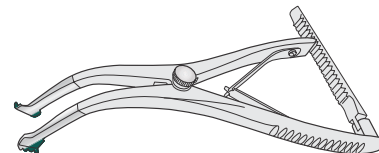

Code	Description
SB-OR/CAL004	Baby, 40mm opening, with teeth, 10mm wide tip, 160mm long
SB-OR/CAL004a	50mm opening, with teeth, 10mm wide tip, 240mm long

Harrison Bone Holding Forceps

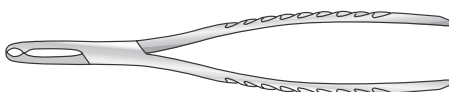

Code	Description
SBC-OR/30d	190mm long

St Thomas Bone Holding Forceps

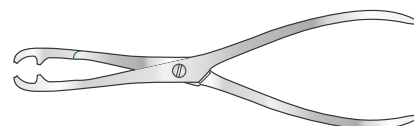

Code	Description
SBOR/403c	182mm long

Bone Holding Forceps

Burns Bone Holding Forceps

Box joint

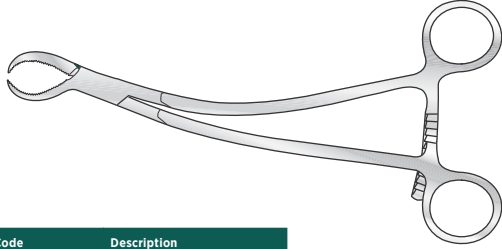

Code	Description
SB-OR/29a	200mm long

Scarf Type Clamp

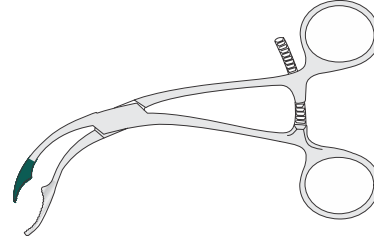

Code	Description
SB-OR/SCA	150mm long

Orthopaedic Grasping Forceps

Box joint

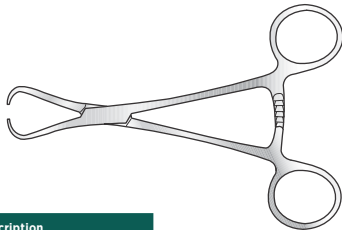

Code	Description
SB-OR/29b	125mm long
SB-OR/29c	165mm long

Lowman Bone Holding Clamp

Infant 125mm long
Child 175mm long
Adult 205mm long

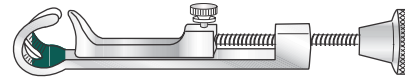

Code
SB-OR/28

Reduction Forcep

With adjustable lock

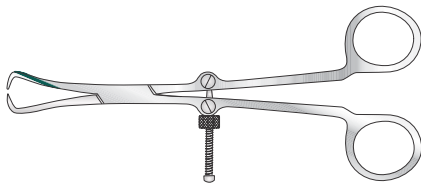

Code	Description
SB-OR/RED001a	Small, 135mm long
SB-OR/RED001b	Large, 168mm long

Parker Modified Lowman Bone Holding Clamp, Single

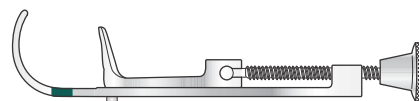

Code	Description
SB-OR/5644	160mm long

Verbrugge Bone Holding Forceps

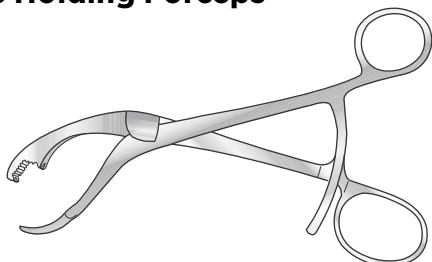

Code	Description
SB-OR/30c	180mm long

Parker Retractor

For use with Lowman clamp

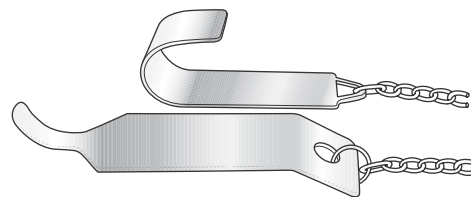

Code	Description
SB-OR/5643	Chain 850mm long

Plaster Spreaders and Shears

Haglund Plaster Spreader

Working part curved in right

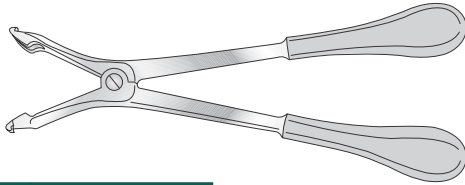

Code	Description
SB-OR/207	280mm long

Plaster Cutter

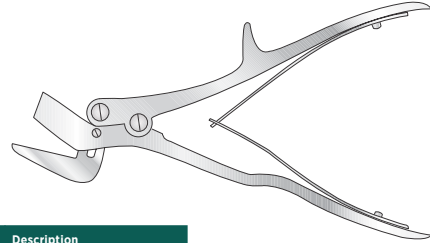

Code	Description
SB-OR/40	240mm long

Lawton Plaster Spreader

Working part curved in right

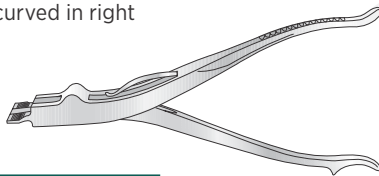

Code	Description
SB-OR/208	220mm long

Bohler Plaster Shears

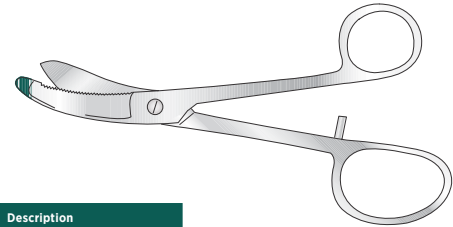

Code	Description
SBOR/38	240mm long

Henning Plaster Spreader

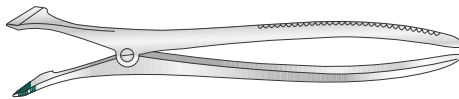

Code	Description
SBOR/211	270mm long

Guys Plaster Shears

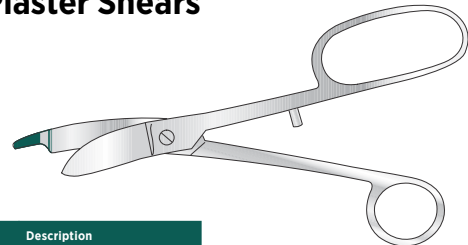

Code	Description
SB-OR/39	240mm long

Wolf Plaster Spreader

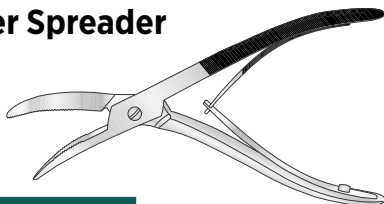

Code	Description
SB-OR/212	180mm long
SB-OR/329	250mm long

Engel Plaster Saw



Code	Description
SB-OR/40b	150mm long

Stille Type Plaster Shears

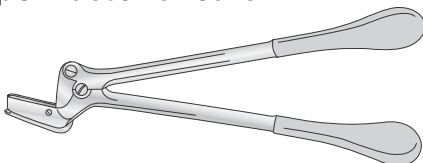

Code	Description
SB-OR/210	380mm long
SB-OR/210a	330mm long
SB-OR/210b	460mm long

Eccentric Plaster Shears

Without heavy serrated blade

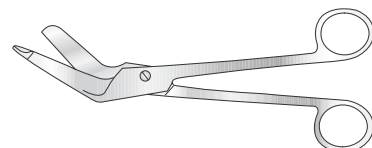

Code	Description
SB-OR/40a	190mm long

Bone Curettes

STAHLÉAN BRAZIL
SAVING LIVES



Bone Curette

Straight, 180mm long

Code	Description	Code	Description
SB-OR/075	Width 2mm	SB-OR/079	Width 10mm
SB-OR/076	Width 4mm	SB-OR/080	Width 12mm
SB-OR/077	Width 6mm	SB-OR/081	Width 14mm
SB-OR/078	Width 8mm	SB-OR/082	Width 16mm

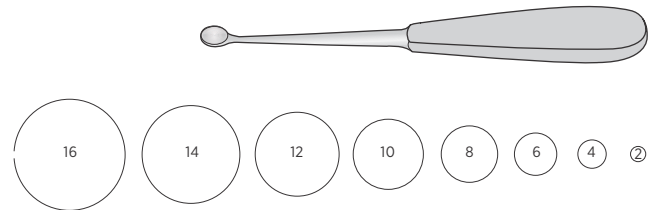

Bone Curette

Straight, 260mm long

Code	Description	Code	Description
SBOR/083	Width 2mm	SB-OR/086	Width 8mm
SB-OR/084	Width 4mm	SB-OR/087	Width 10mm
SB-OR/085	Width 6mm	SB-OR/088	Width 12mm

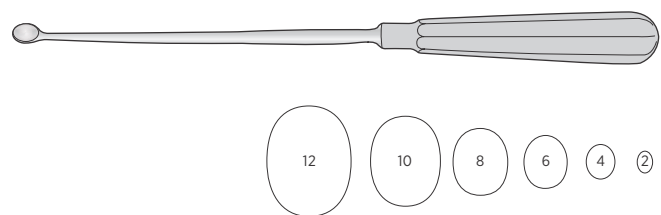

Bone Curette

Straight, 210mm long

Code	Description
SB-OR/089	Width 2mm
SB-OR/090	Width 4mm
SB-OR/091	Width 6mm
SB-OR/092	Width 8mm
SB-OR/093	Width 10mm
SB-OR/094	Width 12mm
SB-OR/095	Width 14mm
SB-OR/096	Width 16mm
SB-OR/097	Width 20mm

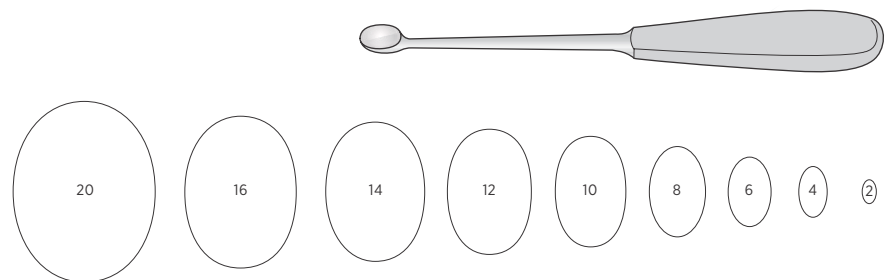

Busche Bone Curette

Angled, 250mm long

Code	Description
SBOR/138	Width 3mm
SB-OR/139	Width 4mm
SB-OR/140	Width 5mm

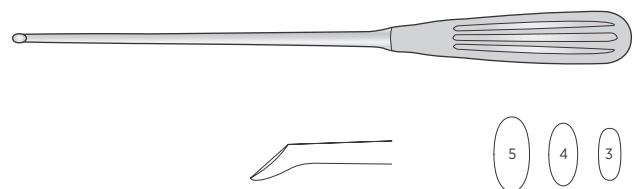

Bruns Bone Curette

225mm long

Code	Description	Code	Description
SB-OR/189	Width 3mm	SB-OR/195	Width 3mm
SB-OR/190	Width 4mm	SB-OR/196	Width 4mm
SB-OR/191	Width 5mm	SB-OR/197	Width 5mm
SB-OR/192	Width 6mm	SB-OR/198	Width 6mm
SB-OR/193	Width 7mm	SB-OR/199	Width 7mm
SB-OR/194	Width 8mm	SB-OR/200	Width 8mm

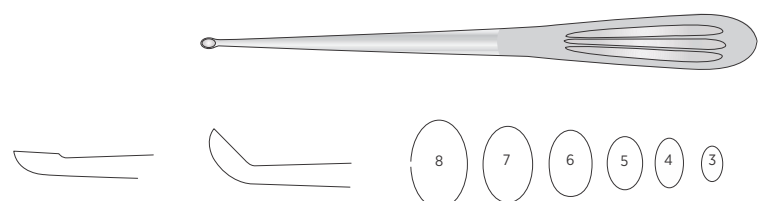

Bone Curettes

STAHLÉAN BRAZIL
SAVING LIVES



Straight, blunt
280mm long

Code	Description
SB-OR/157	Width 6mm
SB-OR/158	Width 8mm
SB-OR/159	Width 10mm
SB-OR/160	Width 12mm
SB-OR/161	Width 14mm

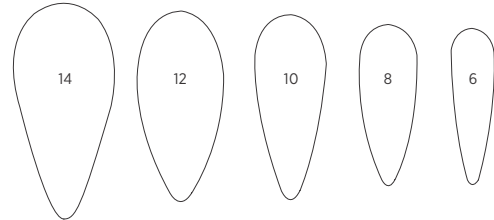

Shroeder Bone Curette

Straight, 310mm long

Code	Description
SB-OR/151	Width 6mm
SB-OR/152	Width 8mm
SB-OR/153	Width 10mm
SB-OR/154	Width 12mm
SB-OR/155	Width 14mm

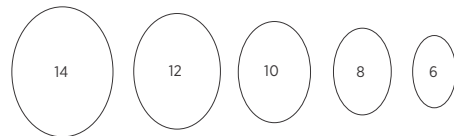

Simon Bone Curette

Straight, 240mm long

Code	Description
SB-OR/145	Width 6mm
SB-OR/146	Width 8mm
SB-OR/147	Width 10mm
SB-OR/148	Width 12mm
SB-OR/149	Width 14mm

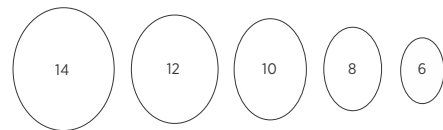

Spinal Curette

Oval, 205mm long

Code	Description	Code	Description
SB-OR/031a	Width 4mm	SB-OR/031e	Width 8mm
SB-OR/031b	Width 5mm	SB-OR/031f	Width 9mm
SB-OR/031c	Width 6mm	SB-OR/031g	Width 10mm
SB-OR/031d	Width 7mm	SB-OR/031h	Width 11mm

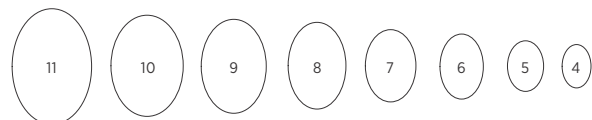
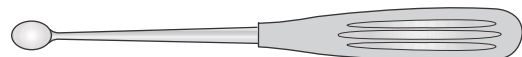

Bone Curettes

STAHLÉAN BRAZIL
SAVING LIVES



Volkman Bone Curette

Straight, 170mm long

Code	Description
SBOR/112	Width 2mm
SBOR/113	Width 3mm
SB-OR/114	Width 4mm
SB-OR/115	Width 5mm
SB-OR/116	Width 6mm

Code	Description
SBOR/117	Width 8mm
SB-OR/118	Width 10mm
SB-OR/119	Width 12mm
SB-OR/120	Width 14mm

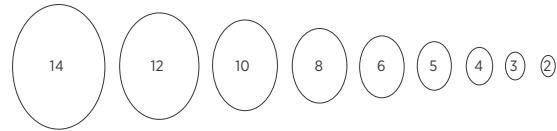
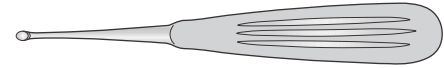

Volkman Bone Curette

Straight, 230mm long

Code	Description
SB-OR/SH.5687	Bowl width 10mm, bowl length 14.5mm



Wallich Bone Curette

Blunt

Code	Description
SB-OR/162	420mm long

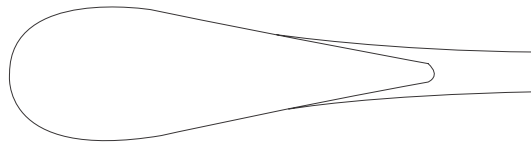

Straight, 170mm long

Code	Description
SB-OR/122	Width 3.5mm
SB-OR/123	Width 5.5mm



Charnley Bone Curette

With T handle,
380mm long

Code	Description
SB-OR/N040	Large, 20 x 14mm
SB-OR/N041	Medium, 17 x 12mm
SB-OR/N042	Small, 11 x 8mm

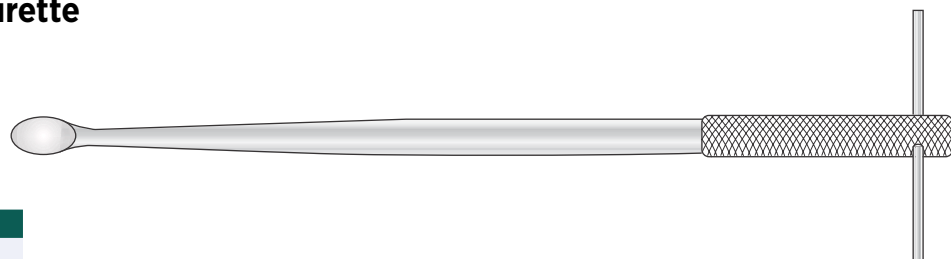

Bone Curettes

STAHLÉAN BRAZIL
SAVING LIVES



Sypert Bone Curette

Blue acetal "Suregrip" handle, 380mm long

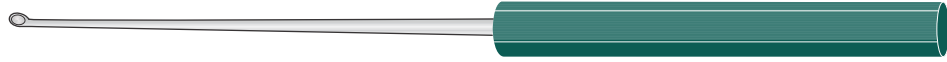

Code	Description
SC-OR/236	Width 3mm
SC-OR/237	Width 4mm
SC-OR/238	Width 5mm

Code	Description
SC-OR/240	Width 3mm
SC-OR/241	Width 4mm
SC-OR/245	Width 5mm



Blue acetal "Suregrip" handle, 410mm long



Code	Description
SC-OR/249	Width 3mm
SC-OR/250	Width 4mm
SC-OR/251	Width 5mm

Code	Description
SC-OR/252	Width 3mm
SC-OR/253	Width 4mm
SC-OR/254	Width 5mm



Caspar Bone Curette

Blue acetal "Suregrip" handle, 220mm long

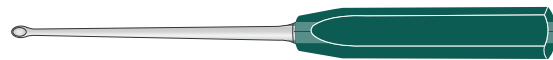

Code	Description
SC-OR/230	Width 3.5mm
SC-OR/231	Width 4.5mm
SC-OR/232	width 5.5mm

Code	Description
SC-OR/233	Width 3.5mm
SC-OR/234	Width 4.5mm
SC-OR/235	Width 5.5mm



Bone Curette

Blue acetal "Suregrip" handle, 270mm long, straight



Code	Description
SC-OR/226	Width 4mm
SC-OR/227	Width 6mm
SC-OR/228	Width 8mm
SC-OR/229	Width 10mm

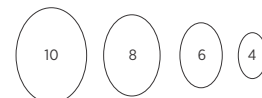

Bone Curettes

Capener Spoon

Blue acetal "Suregrip" handle 285mm long

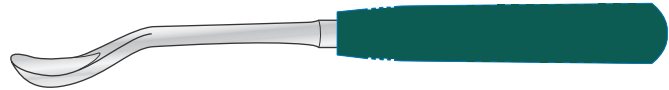

Code	Description
SB-OR/389a	Width 16mm
SB-OR/389b	Width 20mm

Capener Lamina Curette

Blue acetal "Suregrip" handle 300mm long



Code	Description
SB-OR/389c	12 x 32mm
SB-OR/389d	6 x 18mm

Stanley Boyd Curette

Double ended



Code	Description
SBOR/162a	Small - 50mm long
SB-OR/162b	Medium - 200mm long
SB-OR/162c	Large - 250mm long

Volkman Bone Scoop

Double-ended, straight



Code	Description
SB-OR/31	175mm long
SB-OR/213	220mm long
SBOR/175	220mm long

Martini Bone Curette

Shown at half size
double-ended, straight 140mm long



Code	Description
SB-OR/170	Small and medium
SB-OR/171	Medium and large

Bone Lever

STAHLÉAN BRAZIL
SAVING LIVES



240mm long



Code	Description
SB-OR/N011	Slight curve
SB-OR/N012	Full curve

Code	Description
SB-OR/N013	Slight curve
SB-OR/N014	Full curve

Lane Bone Lever

For small bones

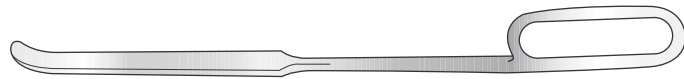

Code	Description
SB-OR/N015	10mm wide, 265mm long

Lane Bone Lever

For small bones, serrated end

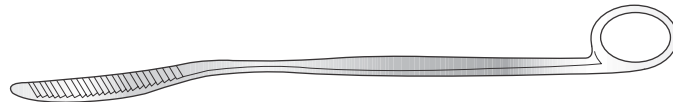

Code	Description
SBC-OR/N016	10mm wide, 260mm long

Trethowan Bone Lever

Ring handle



Code	Description
SB-OR/N017	220mm long

Watson-Jones Bone Lever

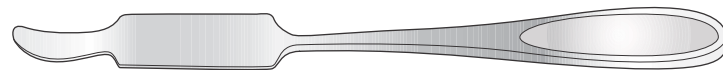

Code	Description
SB-OR/N054	275mm long

Bankhart Bone Lever



Code	Description
SB-OR/SH.5315	300mm long

Retractors

STAHLÉAN BRAZIL
SAVING LIVES

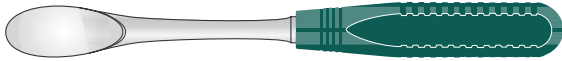

Code	Description
SB-OR/N059A	Spoon elevator 25mm with blue acetal suregrip handle - large



Code	Description
SB-OR/N059D	With blue acetal suregrip handle - 2



Code	Description
SB-OR/N059B	Curette 27mm with blue acetal suregrip handle - large



Code	Description
SBOR/N059E	8mm cranked blue acetal suregrip handle



Code	Description
SB-OR/N059C	Curette 9mm with blue acetal suregrip handle - small

Charnley Initial Incision Retractor

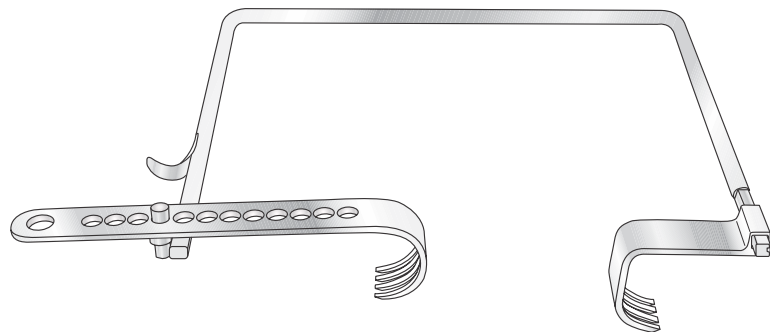

Code	Description
SB-OR/N038a	Frame only
SB-OR/N038b	Weight only, 75mm x 50mm ø
SB-OR/N038s	Goal post pins and chain

Code	Description
SB-OR/N038r	Short blade, 25mm deep
Sb006084	Short blade, 35mm deep
SB-OR/N038c	Short blade, 50mm deep
SBC-OR/N038l	Short blade, 65mm
SB-OR/N038e	Short blade, 75mm deep
SB-OR/N038q	Short blade, 80mm deep
SBOR/N038g	Short blade, 100mm deep
Sb003879	Short blade, 125mm
Sb003880	Short blade, 150mm

Code	Description
Sb006085	Long blade, 35mm deep
SB-OR/N038d	Long blade, 50mm deep
SB-OR/N038k	Long blade, 65mm
SB-OR/N038p	Long blade, 70mm deep
SB-OR/N038f	Long blade, 75mm deep
SBOR/N038h	Long blade, 100mm deep
Sb003877	Long blade, 125mm
Sb003878	Long blade, 150mm
SB-OR/N038m	Long round blade, 50mm deep

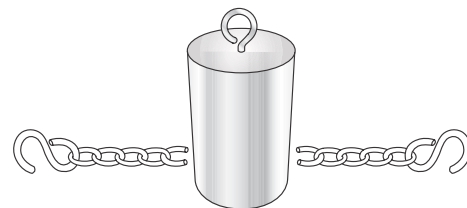

Retractors

STAHLÉAN BRAZIL
SAVING LIVES



Self retaining, internal rack, 210mm long

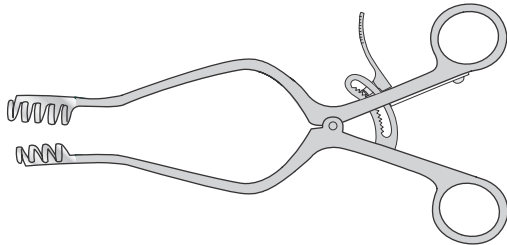

Code	Description
SB-GI/323	4 x 5 teeth, 95mm fully open

Self retaining

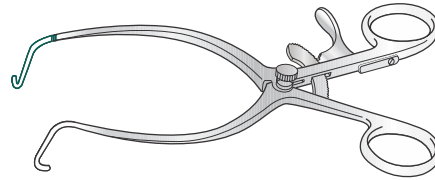

Code	Description
SB-GI/377	175mm

Self retaining, 140mm long

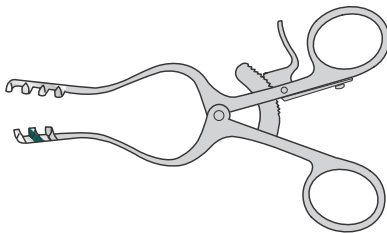

Code	Description
SBC-GI/326	3 x 4 teeth, 60mm fully open
SB-GI/326cr	3 x 4 teeth, 60mm fully open, with cam rack

4 x 5 teeth 50mm blades x 223mm long

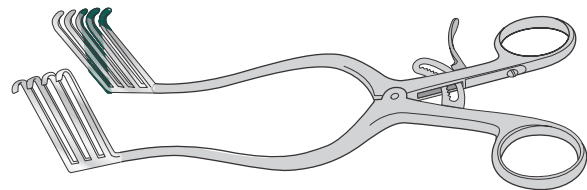

Code	Description
SBGI/325	Standard rack

Refurbishment of orthopaedic sets

Refurbishing instruments can save up to **80%** of the cost of buying new, with compelling evidence to demonstrate effectiveness

Independent research¹ showed that instruments refurbished by Surgical Holdings had a 4x reduction in the amount of residual protein.

The smooth and polished surface has an increased cleaning efficacy, and all refurbishments come with an 18 month warranty as standard. Standard turnaround times are 1 week and an express 2 day service is also available.

Reference: ¹ Data available on file.

Book your orthopaedic set refurbishment on Info@stahleanbrazil.com



Before Refurbishment

After Refurbishment

Retractors, Dissecting Forceps and Hooks

225mm long

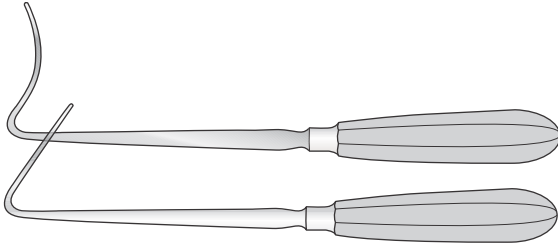

Code	Description
SB-OR/N050	Narrow curve, 13mm blade
SB-OR/N050a	Broad, angular, 20mm blade

Ballance (Volkman) Retractor

203mm long

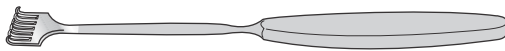

Code	Description
SB-GI/463	1 prong
SB-GI/463a	2 prong
SB-GI/463b	3 prong
SB-GI/463c	4 prong
SB-GI/463d	6 prong

Code	Description
SBGI/463e	1 prong
SB-GI/463f	2 prong
SB-GI/463g	3 prong
SB-GI/463h	4 prong
SB-GI/463i	6 prong

Jackson Burrows Dissecting Forcep

140mm long

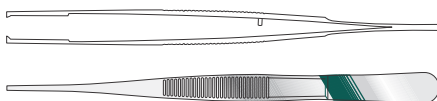

Code	Description
SB-OR/N037	Tongue and groove only
SBOR/N037a	

Charnley-McIndoe Dissecting Forceps

150mm long

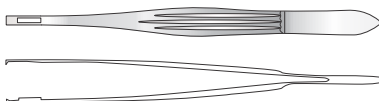

Code	Description
SC-OR/N045a	2-3 teeth

220mm long

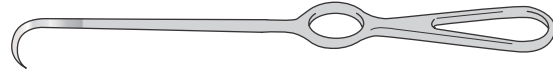

Code	Description
SBOR/N036	Sharp
SB-OR/N036a	Blunt

Langenbeck Bone Hook

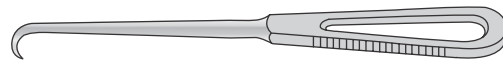

Code	Description
SB-OR/391	200mm long

Dislocation Hook

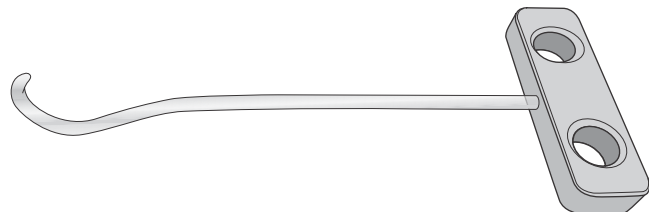

Code	Description
SB-OR/SH-5703	253mm long

Dislocation Hip Hook

Blue acetal "Suregrip" handle

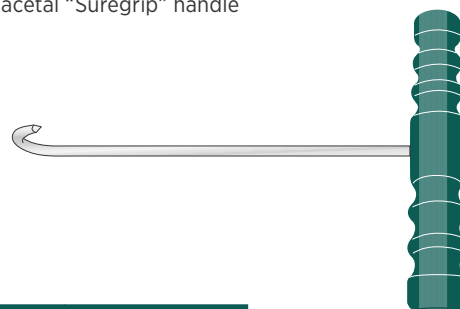

Code	Description
SB-OR/420	185mm long

Raspatories, Burr and Rugines

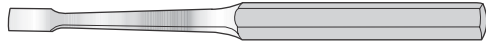

Convex sharp edge, fan shaped end,
with solid pistol handle

Code	Description
SB-OR/310	Width 6.4mm 180mm long
SBOR/313	Width 9.5mm 190mm long
SBOR/311	Width 12.7mm 190mm long
SB-OR/312	Width 19mm 200mm long
SBOR/314	Width 25.4mm 210mm long

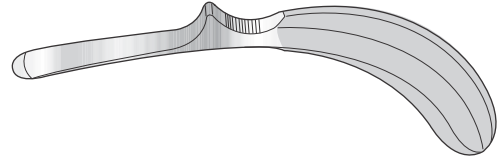

Code	Description
SB-OR/N035	185mm long

205mm Long

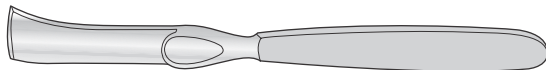

Straight, sharp edge,
fan shaped, hollow handle

Code	Description
SB-OR/242	Width 10mm
SB-OR/243	Width 15mm
SB-OR/244	Width 20mm

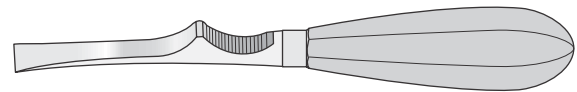

Code	Description
SBOR/N034	210mm long

Satin handle, 155mm long

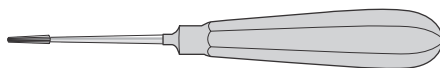

Curved end, chisel edge,
hollow handle

Code	Description
SB-OR/403	3.5mm ø x 17mm
SBOR/403a	4.5mm ø x 17mm
SBOR/403b	5.0mm ø x 17mm

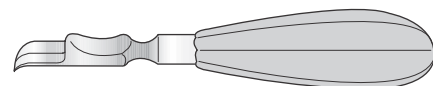

Code	Description
SBOR/N033	160mm long

Osteotomes, Chisels and Gouges

Blue acetal "Suregrip" handle, 180mm long



Code	Description
SB-OR/SH5347a	4mm

Blue acetal "Suregrip" handle, straight, 265mm long



Code	Description
SB-OR/362	Width 6mm
SB-OR/363	Width 10mm
SBOR/364	Width 12mm

Code	Description
SB-OR/365	Width 15mm
SB-OR/366	Width 20mm
SB-OR/367	Width 25mm

Blue acetal "Suregrip" handle, 250mm long



Code	Description
SB-OR/384	Width 6mm
SB-OR/385	Width 10mm
SB-OR/386	Width 12mm
SB-OR/387	Width 15mm
SB-OR/388	Width 20mm
SB-OR/389	Width 25mm
SB-OR/390	Width 30mm

Code	Description
SB-OR/390a	Width 6mm
SB-OR/390b	Width 10mm
SB-OR/390c	Width 15mm
SB-OR/390d	Width 20mm
SB-OR/390e	Width 25mm

Cranked, blue acetal "Suregrip" handle, 250mm long

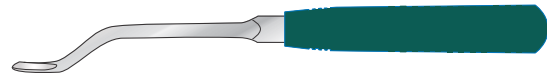

Code	Description
SB-OR/373c	Width 6mm
B	Width 8mm
SB-OR/373j	Width 10mm
SB-OR/373e	Width 11mm
SB-OR/373f	Width 16mm
SB-OR/373k	Width 17mm

Code	Description
SB-OR/373cre	Width 6mm
SB-OR/373dre	Width 8mm
SB-OR/373jre	Width 10mm
SB-OR/373ere	Width 11mm
SB-OR/373fre	Width 16mm
SB-OR/373kre	Width 17mm

Blue acetal "Suregrip" handle, straight, 255mm long



Code	Description
SB-OR/374	Width 6mm
SB-OR/375	Width 8mm
SB-OR/376	Width 10mm
SB-OR/377	Width 12mm
SB-OR/378	Width 13mm

Code	Description
SB-OR/379	Width 15mm
SB-OR/380	Width 18mm
SB-OR/381	Width 20mm
SBOR/382	Width 25mm
SB-OR/383	Width 30mm

Swan neck, blue acetal "Suregrip" handle, 250mm long

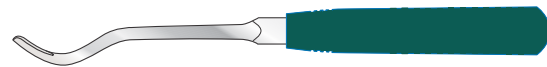

Code	Description

Blue acetal "Suregrip" handle straight, 250mm long

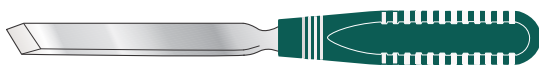

Code	Description
SB-OR/368	Width 6mm
SB-OR/369	Width 10mm
SB-OR/370	Width 12mm

Code	Description
SB-OR/371	Width 15mm
SB-OR/372	Width 20mm
SBOR/373	Width 25mm

Reverse cranked, blue acetal "Suregrip" handle, 245mm long



Code	Description
SB-OR/373ar	Width 11mm
SB-OR/373nr	Width 16mm
SB-OR/373jr	Width 17mm

Code	Description
SC-OR/373or	Width 6mm
SC-OR/373lr	Width 8mm
SC-OR/373nr	Width 10mm

Osteotomes, Chisels and Gouges

Serrated head
180mm long



Code	Description
SB-OR/335	Width 4mm
SB-OR/336	Width 5mm

Serrated head, 180mm long



Code	Description
SB-OR/344	Width 2mm
SB-OR/345	Width 3mm
SB-OR/346	Width 4mm
SB-OR/347	Width 5mm

Code	Description
SB-OR/341	Width 6mm
SB-OR/342	Width 7mm
SB-OR/343	Width 8mm

Serrated head, 180mm long



Code	Description
SB-OR/337	Width 2mm
SB-OR/338	Width 3mm
SBOR/339	Width 4mm
SBOR/340	Width 5mm

Code	Description
SB-OR/341	Width 6mm
SB-OR/342	Width 7mm
SB-OR/343	Width 8mm

200mm long

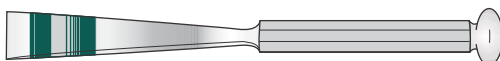

Code	Description
SB-OR/348	Width 10mm
SB-OR/349	Width 15mm
SB-OR/350	Width 20mm
SB-OR/351	Width 25mm
SB-OR/352	Width 30mm

Code	Description
SBOR/348tc	Width 10mm
SB-OR/349tc	Width 15mm
SB-OR/350tc	Width 20mm
SB-OR/351tc	Width 25mm
SB-OR/352tc	Width 30mm

200mm long

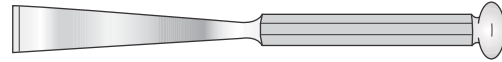

Code	Description
SB-OR/353	Width 10mm
SB-OR/354	Width 15mm
SB-OR/355	Width 20mm
SBOR/356	Width 25mm
SB-OR/357	Width 30mm

Code	Description
SC-OR/355tc	Width 20mm
SC-OR/356tc	Width 25mm
SC-OR/357tc	Width 30mm
SC-OR/356tc	Width 25mm
SC-OR/357tc	Width 30mm

200mm long

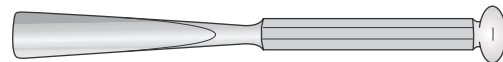

Code	Description
SB-OR/358	Width 10mm
SB-OR/359	Width 15mm
SB-OR/360	Width 20mm
SB-OR/361	Width 25mm

Code	Description
SBOR/358tc	Width 10mm
SB-OR/359tc	Width 15mm
SB-OR/360tc	Width 20mm
SBOR/361tc	Width 25mm

230mm long



Code	Description
SB-OR/392	2mm wide
SB-OR/392a	4mm wide
SB-OR/392b	7mm wide
SB-OR/392c	15mm wide
SB-OR/392d	20mm wide
SB-OR/392e	25mm wide
SB-OR/392f	30mm wide
SB-OR/392g	38mm wide
SB-OR/392h	44mm wide
SB-OR/392i	50mm wide

Code	Description
SBOR/392j	15mm wide
SB-OR/392k	20mm wide
SB-OR/392m	25mm wide
SB-OR/392n	30mm wide
SB-OR/392o	38mm wide
SB-OR/392p	40mm wide
SB-OR/392q	44mm wide
SB-OR/392r	50mm wide

Osteotomes, Chisels and Gouges

190mm long

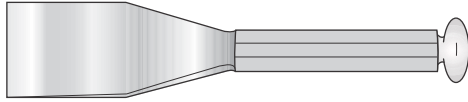

Code	Description
SB-OR/NO62a	Width 38mm
SB-OR/NO62b	Width 50mm

150mm long



Code	Description
SBC-OR/16-4	4mm wide
SB-OR/16-6	6mm wide
SB-OR/16-8	8mm wide

Rectangular, for curved standard stems



Code	Description
SB-OR/N008	135mm long
SB-OR/N008a	255mm long

Blue acetal "Suregrip" handle, 285mm long



Code
SB-OR/N008b

150mm long



Code	Description
SC-OR/14-4	4mm wide
SC-OR/14-6	6mm wide
SC-OR/14-8	8mm wide

Straight, 170mm long



Code	Description	Code	Description
SB-OR/290	Width 5mm	SB-OR/292	Width 9mm
SB-OR/291	Width 7mm	SB-OR/293	Width 11mm

150mm long



Code	Description
SBOR/18-4	4mm wide
SBOR/18-4	6mm wide
SB-OR/18-4	8mm wide

Straight



Code	Description	Code	Description
SBC-OR/283	Width 3mm	SB-OR/294	Width 3mm
SB-OR/284	Width 4mm	SB-OR/287	Width 4mm
SB-OR/285	Width 5mm	SB-OR/295	Width 5mm
SB-OR/286	Width 6mm	SB-OR/288	Width 6mm
		SB-OR/289	Width 7mm

Wire Cutters and Pliers

STAHLÉAN BRAZIL
SAVING LIVES

Tungsten carbide edge, for cutting up to and including 6mm \varnothing

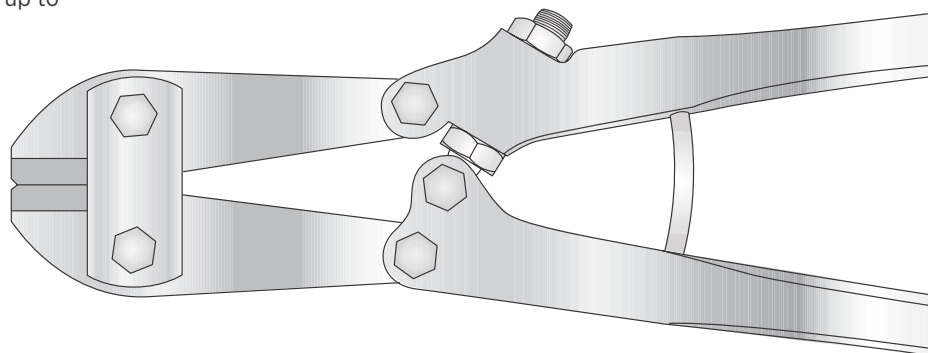

Code	Description
SB-OR/258	450mm long
SB-OR/259	560mm long

Tungsten carbide edge, for cutting Kirschner wires up to and including 5.5mm \varnothing

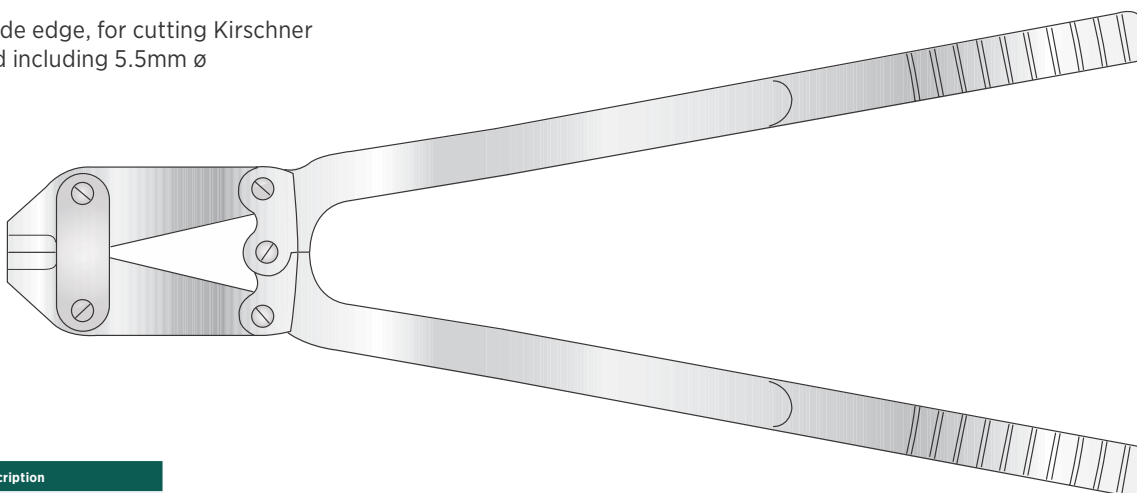

Code	Description
SB-OR/07a	480mm long

Tungsten carbide edge, for cutting Kirschner wires up to 4mm \varnothing

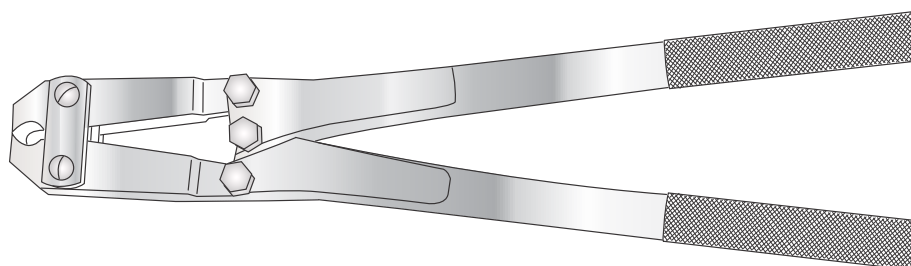

Code	Description
SB-OR/261	380mm long

Wire Cutters and Pliers

175mm long

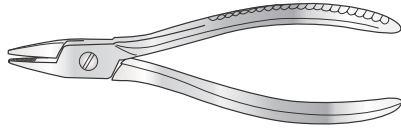

Stainless steel, tungsten carbide edge, for cutting Kirschner wire up to 1.6mm



Code
SB-OR/273

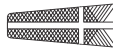

Code
SB-OR/275

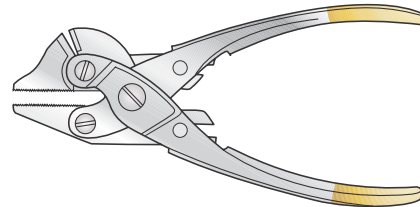

190mm long

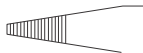
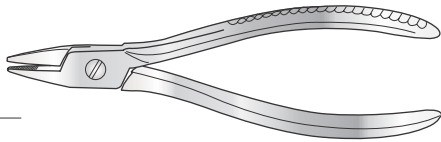

Code
SB-OR/274

Code	Description
SB-OR/271a	TC 180mm long
SB-OR/271b	Non TC for cutting soft wire only, max cut 1.6mm, 180mm long

Stainless steel

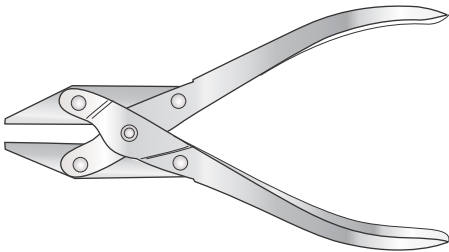

Code	Description
SB-OR/49b	185mm

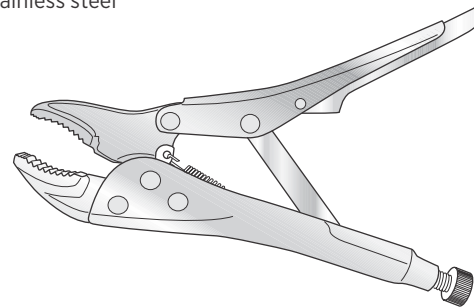

Code	Description
SBOR/N052	190mm long

Sterile Arthrodesis & Kirschner Wires

- 4 Highest grade implant quality stainless steel to ISO 5832-1
- 4 Reduces risk of sharps injuries to Sterile Services personnel
- 4 All popular sizes in stock and can manufacture any custom size, including threaded wires

Turn to page 175 to see our range of sterile Arthrodesis and Kirschner wires

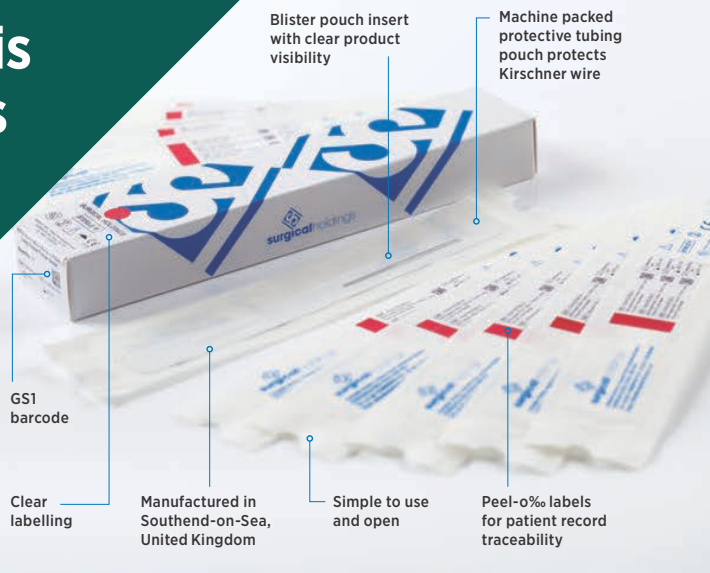

Accessories

STAHLÉAN BRAZIL
SAVING LIVES



Code	Description
SB-OR/49a	150mm long

Angled to cut soft wire only, max cut 1.2mm

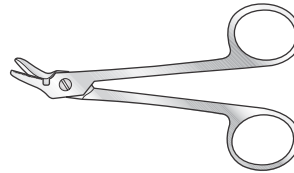

Code	Description
SBOR/07b	120mm long

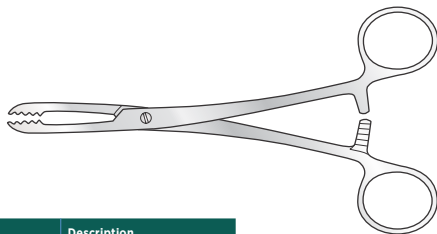

Code	Description
SB-OR/393	180mm long

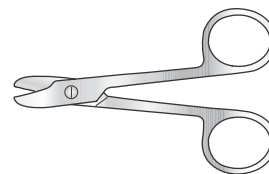

Code	Description
SBOR/07c	110mm long

Slotted, 1-2 teeth



Code	Description
SB-OR/N045	180mm long

Arthroscope Repair

Stahlean brazil highly skilled and experienced technicians will return scopes to the manufacturer's original specification. All parts are brand new and have full traceability. stahlean brazil also manufacture their own fibre optic light bundles.



18 month guarantee on the repair



Free educational visits to our scope workshop and see all our repair facilities



OEM optical specification followed where possible



Personal collection and delivery



Laser welding for sheaths

*MHRA Managing Medical Devices – April 2016

Book your endoscope repair by emailing Info@stahleanbrazil.com



Mallets

STAHLÉAN BRAZIL
SAVING LIVES



With serrated head, 170mm long



Code	Description
SB-OR/023	190 grams

Blue acetal, 240mm long

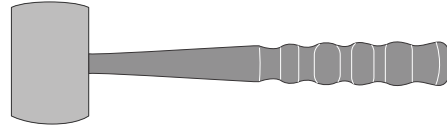

Code	Description
SB-OR/LE1001	340 grams, vertical end

Blue acetal "Suregrip" handle, 275mm long

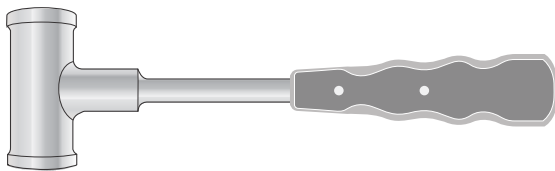

Code
SB-OR/270A-BH

Blue acetal, 255mm long

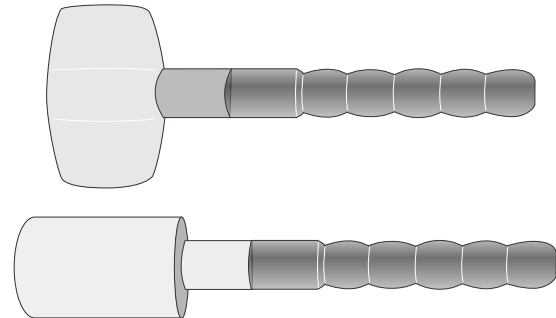

Code	Description
SB-OR/22a	520 grams, vertical end
SB-OR/22	650 grams, horizontal end

Stainless steel, 270mm long

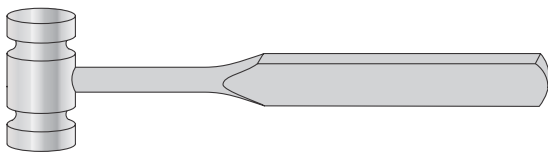

Code	Description
SB-OR/270	640 grams
SB-OR/271	1020 grams

Stainless steel, 135mm long

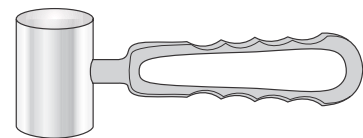

Code	Description	Code	Description
SB-OR/N044c	650 grams	SB-OR/N044	1150 grams
SB-OR/N044b	920 grams	SB-OR/N044a	1340 grams

Stainless steel, with pistol grip*
240mm long

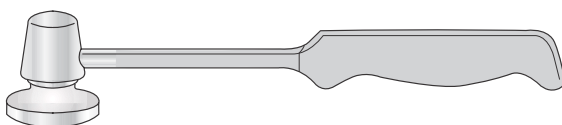

Code	Description
SB-OR/20	580 grams

Stainless steel, with extended handle and strong welded head, 190mm long

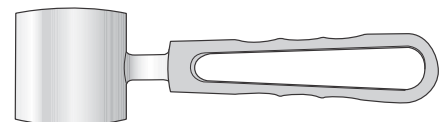

Code	Description
SB-OR/N044rc	1000 grams

Mallets



Surgical Holdings pattern, stainless steel, 170mm long

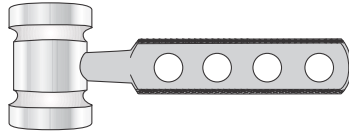

Code	Description
SB-OR/N055b	800 grams
SB-OR/N055	880 grams
SB-OR/N055a	1020 grams

With renewable acetal ends, 190mm long

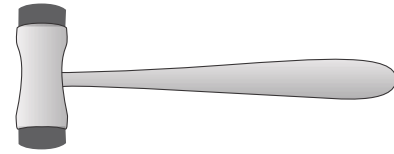

Code	Description
SBOR/N047a	280 grams
SB-OR/N048	Replacement end - pair

one flat and one domed end, 180mm long

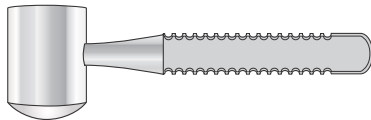

Code	Description
SB-OR/272a	960 grams
SCB-OR/272c	750 grams

Stainless steel with blue acetal "Suregrip" handle 270mm long

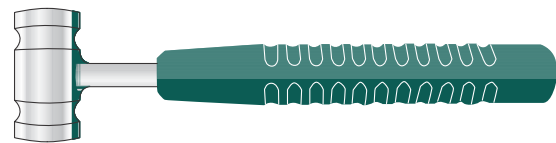

Code	Description
SBOR/410	720 grams

Code	Description
SB-OR/412	900 grams

Stainless steel, one plain and one serrated side, 190mm long

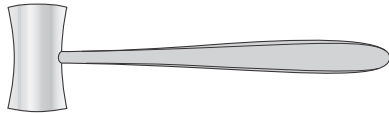

Code	Description
SBC-OR/N047	280 grams

Stainless steel with blue acetal "Suregrip" handle 200mm long

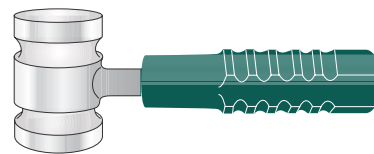

Stainless steel, one flat and one domed end

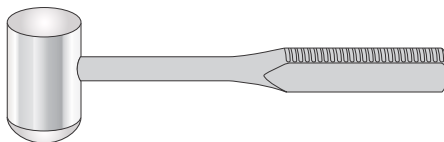

Code	Description
SBOR/272	950 grams, 240mm long
SB-OR/272b	1110 grams, 270mm long

Code	Description
SB-OR/414BH	660 grams
SB-OR/415BH	790 grams

Code	Description
SB-OR/416BH	1020 grams
SB-OR/417BH	1400 grams

Stainless steel, 205mm long

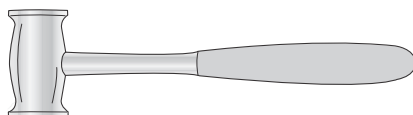

Code	Description
SB-OR/23	270 grams

Stainless steel with blue acetal "Suregrip" handle domed faced head, 200mm long

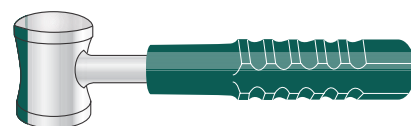

Code	Description
SB-OR/418BH	650 grams

Raspatories, Files and Punches

Putti Raspatory



Code	Description
Sb-OR/12	300mm long

Bone File and Raspatory

Stainless steel



Code	Description
Sb-OR/12a	215mm long

Austin Moore Type Raspatory

Including tommy bar,
295mm long

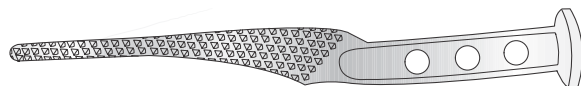

Code	Description
Sb-OR/HP001	Standard
Sb-OR/HP002	Narrow (not illustrated)

Thompson Type Raspatory

Including tommy bar

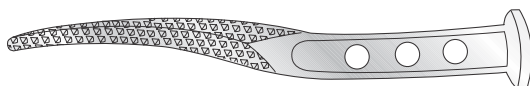

Many other types available

Supply a drawing of the prosthesis - we will make the rasp in any batch size you require. The teeth will be chipped up at 0.75mm per face over and above the size of the prosthesis stem, to allow for cementing.

Code	Description
Sb-OR/HP003	270mm long

Miller Bone File

180mm long



Code	Description
Sb-OR/318	Short end
Sb-OR/319	Slight curve
Sb-OR/322	Full curve

McGoey Punch

Double ended, 220mm long

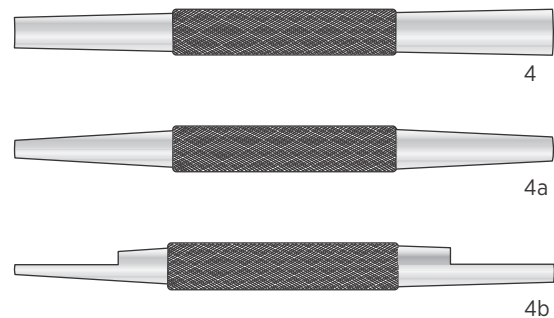

Code	Description
Sb-OR/N04	13 x 19mm
Sb-OR/N04a	6 x 10mm
Sb-OR/N04b	13 x 6mm half round

Smillie Bone Punch



Head size 15 x 19.5mm



Head size 9.5 x 15.5mm

Code	Description
Sb-OR/N018	Straight 140mm long
Sb-OR/N019	Cranked 175mm long

Pushers, Impactors and Skids

With nylon head

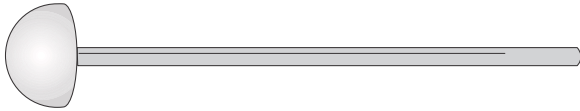

Code	Description
Sb-OR/N020	295mm long

With T handle



Code	Description
Sb-OR/HR001	335mm long

Charnley Prosthesis Pusher

Stainless steel handle
with nylon insert



Code	Description
Sb-OR/N021	180mm long

Moore Femoral Head Extractor

With T handle

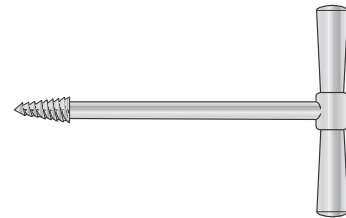

Code	Description
Sb-OR/N005	150mm long
Sb-OR/N006	205mm long

Judet Impactor

Stainless steel handle
with nylon head

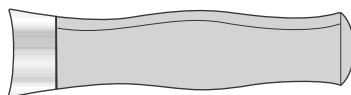

Code	Description
Sb-OR/N009	140mm long

Murphy Skids

Double ended, 355mm long



Code	Description
Sb-OR/N007	Uncoated
SbDIA/111	Coated

Femoral Pusher

Head impactor, white Pomalux



Code	Description
Sb-OR/N053	31mm ø x 180mm long

Murphy Skids

Single ended, 330mm long



Code	Description
Sb-OR/N007a	Coated

Elevators

STAHLÉAN BRAZIL
SAVING LIVES



Adson Periosteal Elevator

Serrated grip, 165mm long

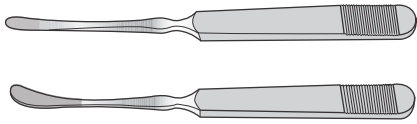

Code	Description
Sb-OR/N028	7mm wide

Code	Description
Sb-OR/N029	5mm wide
Sb-OR/N030	7mm wide

Langenbeck Elevator

Straight

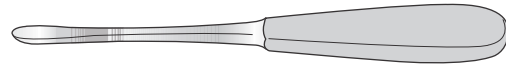

Code	Description
Sb-OR/302	200mm long

Bristow Periosteal Elevator

Sharp edge



Code	Description
Sb-OR/N010	240mm long

MacDonald Dissector Double Ended



Code	Description
Sb-GI/285	191mm long

Doyen Periosteal Elevator

Satin finish handle

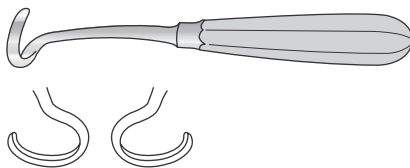

Code	Description
Sb-OR/N031	Right
Sb-OR/N032	Left

Code	Description
Sb-OR/256	Right
Sb-OR/255	Left

Pennybacker Elevator

Curved, sharp, 6mm wide

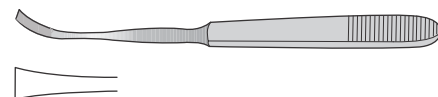

Code	Description
SbOR/N025	170mm long

Key Periosteal Elevator

190mm long



Code	Description
Sb-OR/N023	10mm wide
Sb-OR/N024	13mm wide

Periosteal Elevator

Straight

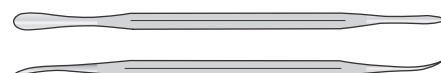

Code	Description
Sb-OR/19a	175mm long

Elevators

STAHLÉAN BRAZIL
SAVING LIVES



Adson Periosteal Elevator

Serrated grip, 165mm long

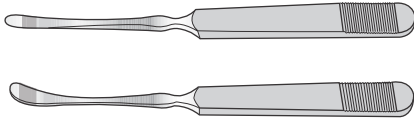

Code	Description
Sb-OR/N028	7mm wide

Code	Description
Sb-OR/N029	5mm wide
Sb-OR/N030	7mm wide

Langenbeck Elevator

Straight

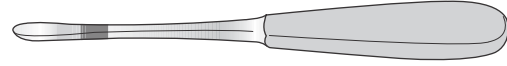

Code	Description
Sb-OR/302	200mm long

Bristow Periosteal Elevator

Sharp edge



Code	Description
Sb-OR/N010	240mm long

MacDonald Dissector Double Ended



Code	Description
Sb-GI/285	191mm long

Doyen Periosteal Elevator

Satin finish handle

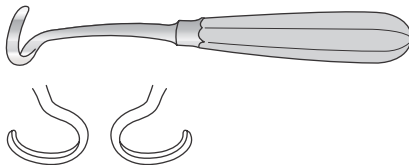

Code	Description
Sb-OR/N031	Right
Sb-OR/N032	Left

Code	Description
Sb-OR/256	Right
Sb-OR/255	Left

Pennybacker Elevator

Curved, sharp, 6mm wide

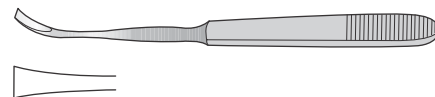

Code	Description
SbOR/N025	170mm long

Key Periosteal Elevator

190mm long



Code	Description
Sb-OR/N023	10mm wide
Sb-OR/N024	13mm wide

Periosteal Elevator

Straight



Code	Description
Sb-OR/19a	175mm long

Retractors and Bone Levers

Fakuda Type Retractor

230mm long

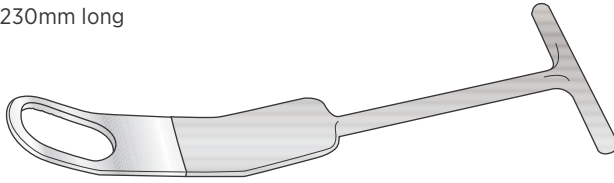

Code

Sb-OR/SH5507

Hohmann Retractor

45° angle, 200mm long



Code

Sb-OR/SH5394

Hohmann Tapered Spike Retractor

225mm overall length

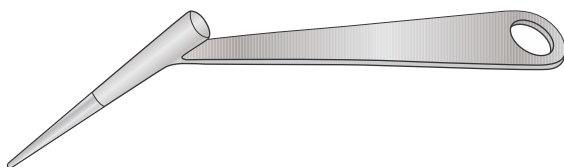

Code

Sb-OR/308a

Posterior Bone Lever

230mm long

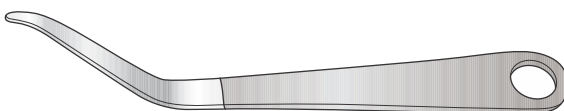

Code

Sb-OR/308r

Trethowan Bone Lever

Bent, ring handle 222mm long, 280mm long

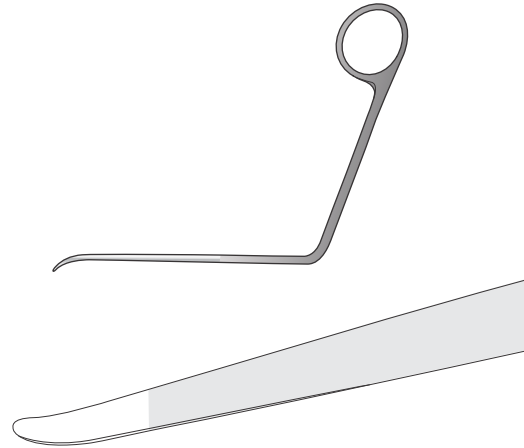

Code	Description
Sb-OR/no17b	90° angle
Sb-OR/no17c	70° angle (illustrated)
Sb-OR/no17d	45° angle

Stahlean brazil Instruments

Offering more than 50 years of quality and safety, know-how and innovation, technology

Stahleanbrazil provide you with:

- 2 year warranty
- Unique interchangeable handles and working parts
- Handle and rod design gives extra stability and robustness
- We perform maintenance and modifications in-house
- Custom designs



Exclusive distributor

Info@stahleanbrazil.com

Sb-PL/056 152mm long

Saws, Shears and Knives

Gigli Saw Handles

Per pair

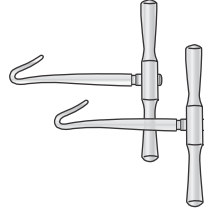

Code	Description
Sb-OR/08	65mm long

Guys Tenotomy Knife



Code	Description
Sb-OR/N046	140mm long

Charnley Saws

Code	Description
Sb-OR/10c	500mm long
Sb-OR/11c	700mm long

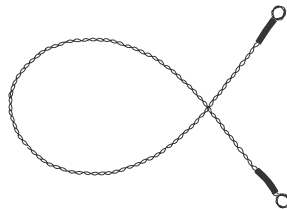

Smillie Menisectomy Knife

175mm long

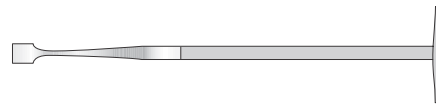

Gigli Saws

Code	Description
Sb-OR/09	300mm long
Sb-OR/10	500mm long
Sb-OR/11	700mm long

Code	Description
Sb-OR/048	Straight

Collin Rib Shears

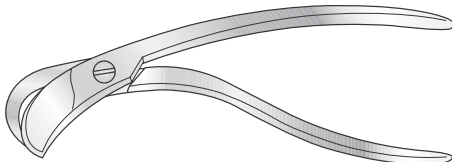

Code	Description
Sb-OR/001	195mm long

Smillie Menisectomy Knife

Protruding beak at base, 175mm long

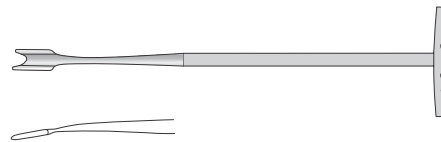

Code	Description
Sb-OR/N0048a	Curved to right
Sb-OR/N0048b	Curved to left

Screw and Plate Instruments

Allen Key Sets

Bright guard



Code	Description
Sb-OR/N051	1.5mm - 10mm

To order quote SB-OR/N051
then add size required
e.g. SC-OR/N051-1.5

Size mm	Overall Length
1.5	63mm
2.0	77mm
2.5	87mm
3.0	93mm
4.0	104mm
5.0	120mm
6.0	141mm
7.0	147mm
8.0	158mm
10.0	180mm

Orthopaedic Ruler Stainless Steel



Code	Description
Sb-OR/51a	Metric, 300mm

Pins

STAHLÉAN BRAZIL
SAVING LIVES



Denham Pin

Temporary implants, material conforms to BS 7252: Part 1: 1997. ISO 5832-1: 1997. Comp.D. CE marking available on request.



Code	Size
SC-DP/1-3SE	3.96mm dia x 203mm long trocar/3 side end
SC-DP/1SQ	3.96mm dia x 203mm long trocar/square end
SC-DP/2-3SE	3.96mm dia x 229mm long trocar/3 side end
SC-DP/2SQ	3.96mm dia x 229mm long trocar/square end

Code	Size
SC-DP/3-3SE	4.76mm dia x 203mm long trocar/3 side end
SC-DP/3SQ	4.76mm dia x 203mm long trocar/square end
SC-DP/4-3SE	4.76mm dia x 229mm long trocar/3 side end
SC-DP/4SQ	4.76mm dia x 229mm long trocar/square end

THREE SIDED END OR
SQUARE END IN STOCK
OTHER SIZES AVAILABLE

Steinmann Pins

Temporary implants, material conforms to BS 7252: Part 1: 1997. ISO 5832-1: 1997. Comp.D. CE marking available on request

Various specs available –
contact us for full information

Ø mm*	Ø mm*
1.58	3.96
2.00	4.36
2.38	4.76
2.78	6.00
3.17	6.35
3.57	8.00

LENGTHS 150, 180, 200, 250mm
*Other lengths and diameters available

When ordering, use prefix letters
with size following
e.g. Trocar with one screw end
Ø4.76mm = IPTS/476



IPTT = trocar/trocar ends



IPTS = trocar/trocar with one screw end



IPTSE = trocar/square end



IPTSE3 = trocar/with 3 sided end

Bohler Stirrup

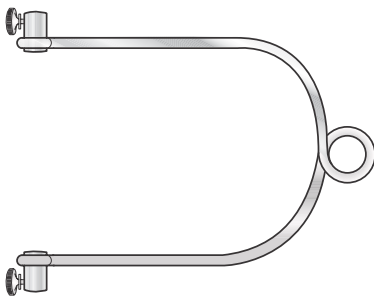

Code	Description
SC-OR/N001	Small 89 x 102mm
SC-OR/N002	Medium 114 x 165mm
SC-OR/N003	Large 152 x 241mm

Steinmann Pin Cap with Screw

Code	Description
SC-OR/54b-4	4mm ø
SC-OR/54c	Replacement screw

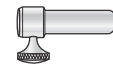

SC-OR 54b

Sterile Kirschner and Arthrodesis Wires

Temporary implants, material conforms to BS 7252: Part 1: 1997. ISO 5832-1: 1997. Comp.D.

Sterile Trocar/ Sterile Trocar Arthrodesis Wires

Code	Size
SBHS325A-S	0.8mm x 70mm
SBHS037-S	0.9mm x 70mm
SBHS055-S	0.9mm x 75mm
SBHS091-S	0.9mm x 100mm
SBHS127-S	0.9mm x 125mm
SBHS145-S	0.9mm x 140mm
SBHS0009-S	0.9mm x 150mm
SBHS163-S	0.9mm x 180mm
SBHS038-S	1.0mm x 70mm
SBHS056-S	1.0mm x 75mm
SBHS092-S	1.0mm x 100mm
SBHS269-S	1.1mm x 90mm
SBHS272-S	1.1mm x 100mm
SBHS275-S	1.1mm x 115mm
SBHS278-S	1.1mm x 125mm
SBHS281-S	1.1mm x 140mm
SBHS0010C-S	1.1mm x 150mm

Code	Size
SBHS290-S	1.1mm x 200mm
SBHS0019B-S	1.25mm x 150mm
SBHS039-S	1.2mm x 70mm
SBHS093-S	1.2mm x 100mm
SBHS129-S	1.2mm x 125mm
SBHS147-S	1.2mm x 140mm
SBHS0010B-S	1.2mm x 150mm
SBHS165-S	1.2mm x 180mm
SBHS183-S	1.2mm x 200mm
SBHS040-S	1.4mm x 70mm
SBHS094-S	1.4mm x 100mm
SBHS112-S	1.4mm x 115mm
SBHS130-S	1.4mm x 125mm
SBHS148-S	1.4mm x 140mm
SBHS0011-S	1.4mm x 150mm
SBHS166-S	1.4mm x 180mm
SBHS184-S	1.4mm x 200mm

Code	Size
SBHS005-S	1.6mm x 50mm
SBHS041-S	1.6mm x 70mm
SBHS095-S	1.6mm x 100mm
SBHS113-S	1.6mm x 115mm
SBHS131-S	1.6mm x 125mm
SBHS0012-S	1.6mm x 150mm
SBHS167-S	1.6mm x 180mm
SBHS185-S	1.6mm x 200mm
SBHS283-S	1.8mm x 200mm
SBHS096-S	2.0mm x 100mm
SBHS114-S	2.0mm x 115mm
SBHS132-S	2.0mm x 125mm
SBHS0013-S	2.0mm x 150mm
SBHS168-S	2.0mm x 180mm
SBHS186-S	2.0mm x 200mm

Sterile Trocar/Sterile Kirschner Wires (Pack of 10 Sterile Singles)

Code	Size
SBHS325-S	0.8mm x 70mm
SBHS043-S	0.9mm x 70mm
SBHS061-S	0.9mm x 75mm
SBHS097-S	0.9mm x 100mm
SBHS133-S	0.9mm x 125mm
SBHS151-S	0.9mm x 140mm
SBHS0014A-S	0.9mm x 150mm
SBHS169-S	0.9mm x 180mm
SBHS044-S	1.0mm x 70mm
SBHS062-S	1.0mm x 75mm
SBHS098-S	1.0mm x 100mm
SBHS270-S	1.1mm x 90mm
SBHS273-S	1.1mm x 100mm
SBHS276B-S	1.1mm x 115mm
SBHS279-S	1.1mm x 125mm
SBHS282-S	1.1mm x 140mm
SBHS285-S	1.1mm x 150mm

Code	Size
SBHS291-S	1.1mm x 200mm
SBHS0015A-S	1.25mm x 150mm
SBHS045-S	1.2mm x 70mm
SBHS099-S	1.2mm x 100mm
SBHS135-S	1.2mm x 125mm
SBHS153-S	1.2mm x 140mm
SBHS0019-S	1.2mm x 150mm
SBHS171-S	1.2mm x 180mm
SBHS189-S	1.2mm x 200mm
SBHS046-S	1.4mm x 70mm
SBHS100-S	1.4mm x 100mm
SBHS118-S	1.4mm x 115mm
SBHS136-S	1.4mm x 125mm
SBHS154-S	1.4mm x 140mm
SBHS0021-S	1.4mm x 150mm
SBHS172-S	1.4mm x 180mm
SBHS190-S	1.4mm x 200mm

Code	Size
SBHS011-S	1.6mm x 50mm
SBHS047-S	1.6mm x 70mm
SBHS101-S	1.6mm x 100mm
SBHS119-S	1.6mm x 115mm
SBHS137-S	1.6mm x 125mm
SBHS0017-S	1.6mm x 150mm
SBHS173-S	1.6mm x 180mm
SBHS191-S	1.6mm x 200mm
SBHS475-S	1.8mm x 200mm
SBHS102-S	2.0mm x 100mm
SBHS120-S	2.0mm x 115mm
SBHS138-S	2.0mm x 125mm
SBHS0018-S	2.0mm x 150mm
SBHS174-S	2.0mm x 180mm
SBHS192-S	2.0mm x 200mm

OTHER SIZES, FULL AND PARTIALLY THREADED STYLES ARE ALSO AVAILABLE PLEASE CONTACT US WITH YOUR REQUIREMENTS.



Extremities Instruments and Sets

Fine Hand Set

Includes: small stille type mallet 17cm long and 2mm, 4mm, 6mm, 8mm, 10mm and 12mm osteotomes

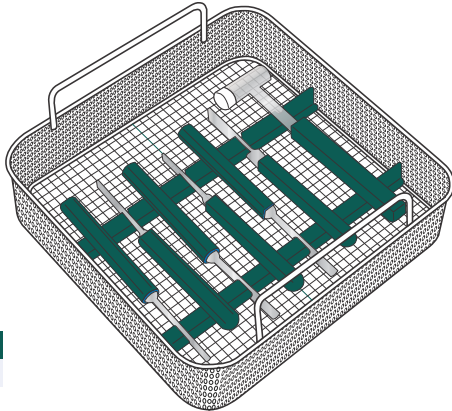

Code

SB-6969

Mini-Lexer Gouges

With blue acetal handle



Code	Description
SB-OR/587-04	4mm wide, 18cm long
SB-OR/587-06	6mm wide, 18cm long
SB-OR/587-08	8mm wide, 18cm long
SB-OR/587-10	10mm wide, 18cm long

Mini-Lexer Osteotome and Gouge Set

Includes 4mm, 6mm, 8mm, 10mm gouges 18cm long and 2mm, 4mm, 6mm, 8mm and 10mm osteotomes 18cm long

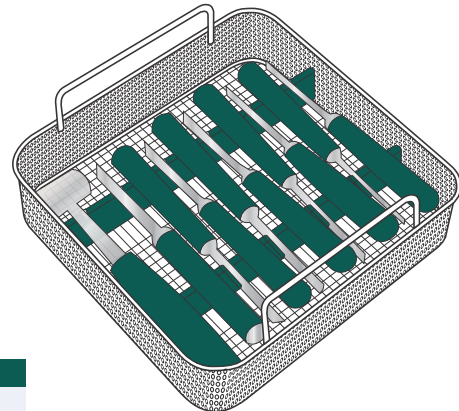

Code

SB-OR/587

Flexible Chisels and Blades



Code	Description
SB-OR/593	Allen key for flat chisel blades introducer handle 185mm long
SB-OR/594	Chisel blade 5mm for introducer handle
SB-OR/594A	Chisel blade 5mm curved for introducer handle
SB-OR/595	Chisel blade 10mm for introducer handle
SB-OR/595A	Chisel blade 10mm curved for introducer handle
SB-OR/596	Chisel blade 15mm for introducer handle
SB-OR/596A	Chisel blade 15mm curved for introducer handle
SB-6954	Introducer handle for flat chisel blades 185mm long

Mini Fine Hand Osteotomes

With blue acetal handle



Code	Description
SB-6956	2mm wide, 165mm long
SB-6957	4mm wide, 165mm long
SB-6958	6mm wide, 165mm long
SB-6959	8mm wide, 165mm long
SB-6960	10mm wide, 165mm long
SB-6961	12mm wide, 165mm long

Mini-Lexer Osteotomes

With blue acetal handle



Code	Description
SB-OR/588-02	2mm wide, 18cm long
SB-OR/588-04	4mm wide, 18cm long
SB-OR/588-06	6mm wide, 18cm long
SB-OR/588-08	8mm wide, 18cm long
SB-OR/588-10	10mm wide, 18cm long

Shoulder Instruments

STAHLÉAN BRAZIL
SAVING LIVES



Kolbel Soft Tissue Retractor

Single-pronged, angled, 190mm

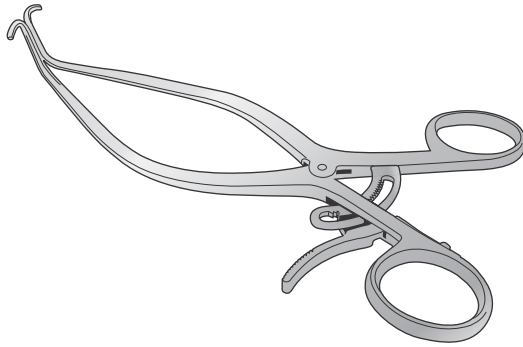

Code

Sb004637943

Kolbel Soft Tissue Retractor

Single-pronged, straight, very fine tips, 190mm

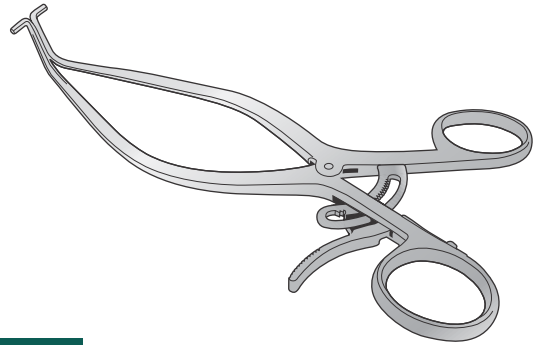

Code

Sb004636943

Kolbel Soft Tissue Retractor

Double pronged, angled, 190mm

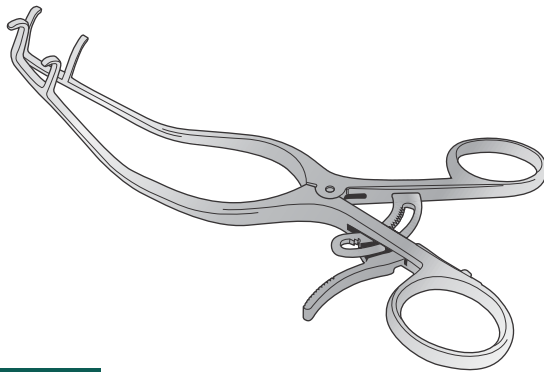

Code

Sb004454965

Capsule Spreader

Single-pronged, fine, 90° curved, 165mm

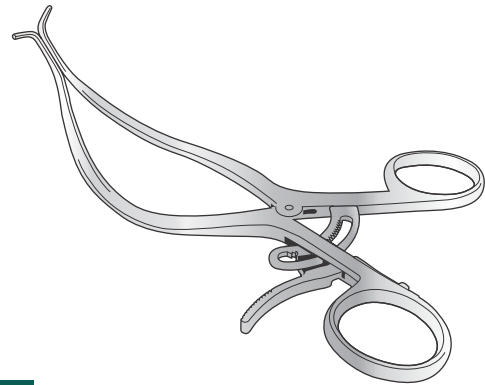

Code

Sb004455954

Fukuda-Kujat Humeral Head Retractor

35mm, wide blade, 225mm

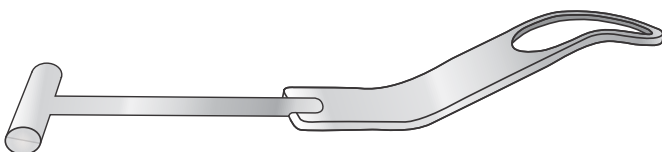

Code

Sb0046351113



STAHLÉAN BRAZIL

SAVING LIVES

CONTACT US

Office in são paulo

 +5511972111007

 +5511933211007

 +923347711007

 @stahleanbrazil

 info@stahleanbrazil.com

 www.stahleanbrazil.com