

STAHLÉAN BRAZIL
SAVING LIVES



General Instruments



www.stahleanbrazil.com

General Instruments

Artery Forceps	3
Clamps	6
Spring Forceps	7
Tissue Forceps	9
Sponge Holding and Sterilising Forceps	11
Other Forceps	12
Scissors	13
Needle Holders	14
Combined Scissor and Needle Holders	15
Bag and Towel Clips	17
Retractors	18
Dissectors and Probes	20
Miscellaneous	22
Hollow Ware	23
Silicone Matting	24
Sterilising Baskets	25
Optical Fibre Cables	26



ARTERY FORCEPS

STAHLÉAN BRAZIL
SAVING LIVES



Adson Artery Forceps

Box joint, 180mm long

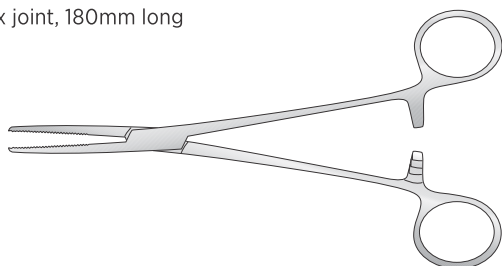

Serrated jaws

Code	Description
Sb-GI/034	Straight
Sb-GI/034a	Curved

1-2 teeth

Code	Description
Sb-GI/034b	Straight
Sb-GI/034c	Curved

Cushing Artery Forceps

Box joint, fine, half serrated jaws, 140mm long

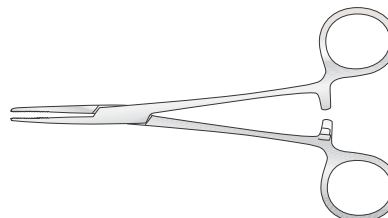

Code	Description
Sb-GI/001	Straight
Sb-GI/002	Curved

Cairns Artery Forceps

Box joint, half serrated jaws
145mm long

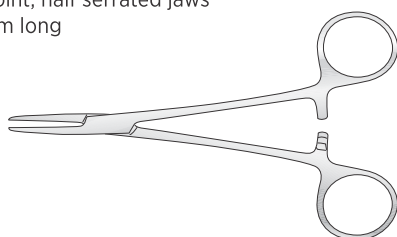

Serrated jaws

Code	Description
Sb-GI/415	Straight

1-2 teeth

Code	Description
Sb-GI/020	Curved
Sb-GI/021	Curved to side

Dunhill Artery Forceps

Box joint, fine serrations

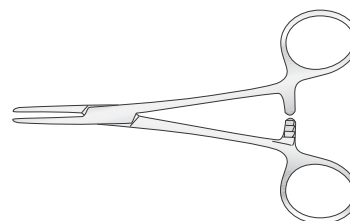

Straight

Code	Description
Sb-GI/065	135mm long
Sb-GI/065a	190mm long

Curved

Code	Description
Sb-GI/043	135mm long
Sb-GI/468	180mm long

Crile Artery Forceps

Box joint, serrated jaws

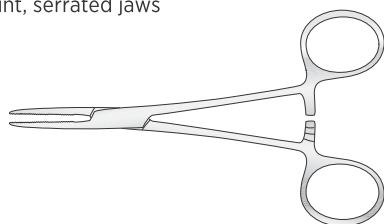

Straight

Code	Description
Sb-GI/014	140mm long
Sb-GI/014a	160mm long

Curved

Code	Description
Sb-GI/015	140mm long
Sb-GI/015a	160mm long

Lawson Tait Artery Forcep

Box joint, straight jaw

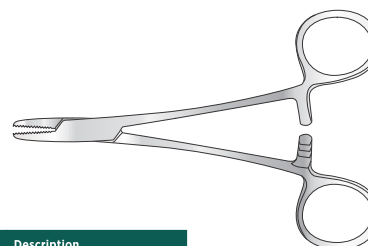

Code	Description
Sb-GI/SH5924	140mm long

ARTERY FORCEPS

STAHLÉAN BRAZIL
SAVING LIVES



Adson Artery Forceps

Box joint, 180mm long

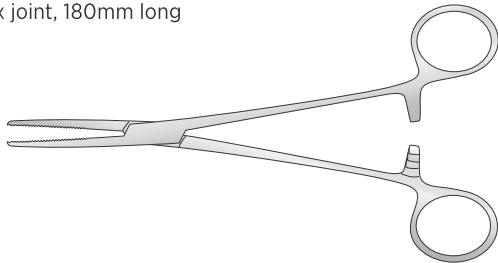

Serrated jaws

Code	Description
Sb-GI/034	Straight
Sb-GI/034a	Curved

1-2 teeth

Code	Description
Sb-GI/034b	Straight
Sb-GI/034c	Curved

Cushing Artery Forceps

Box joint, fine, half serrated jaws, 140mm long

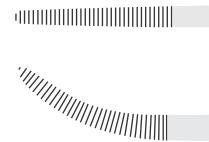
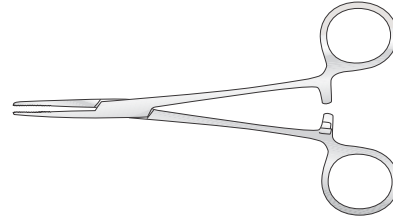

Code	Description
Sb-GI/001	Straight
Sb-GI/002	Curved

Cairns Artery Forceps

Box joint, half serrated jaws
145mm long

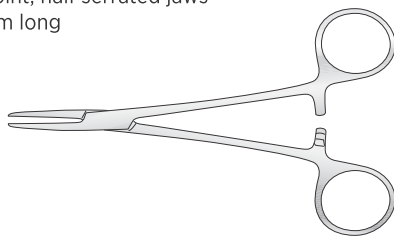

Serrated jaws

Code	Description
Sb-GI/415	Straight

1-2 teeth

Code	Description
Sb-GI/020	Curved
Sb-GI/021	Curved to side

Dunhill Artery Forceps

Box joint, fine serrations

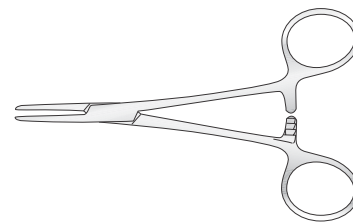

Straight

Code	Description
Sb-GI/065	135mm long
Sb-GI/065a	190mm long

Curved

Code	Description
Sb-GI/043	135mm long
Sb-GI/468	180mm long

Crile Artery Forceps

Box joint, serrated jaws

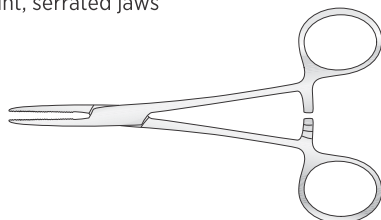

Straight

Code	Description
Sb-GI/014	140mm long
Sb-GI/014a	160mm long

Curved

Code	Description
Sb-GI/015	140mm long
Sb-GI/015a	160mm long

Lawson Tait Artery Forcep

Box joint, straight jaw

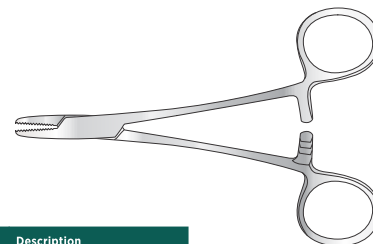

Code	Description
Sb-GI/SH5924	140mm long

ARTERY FORCEPS

STAHLÉAN BRAZIL

SAVING LIVES



Halstead Mosquito Forceps

Standard pattern, haemostatic, box joint

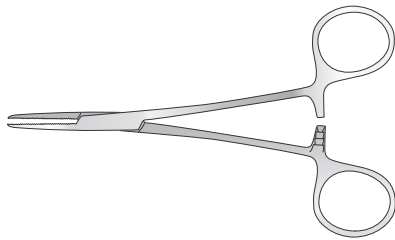

Serrated jaw

Code	Description
Sb-GI/007	Straight 125mm long
Sb-GI/008	Curved 125mm long
Sb-GI/009	Fully curved 125mm long

Micro, 100mm long

Code	Description
Sb-GI/003	Straight, serrated
Sb-GI/004	Curved, serrated
Sb-GI/005	Straight, 1-2 teeth
Sb-GI/006	Curved, 1-2 teeth

1-2 teeth

Code	Description
Sb-GI/010	Straight 125mm long
Sb-GI/012	Straight 190mm long
Sb-GI/011	Curved 125mm long
Sb-GI/013	Curved 190mm long

Heiss Artery Forceps

Box joint, 205mm long

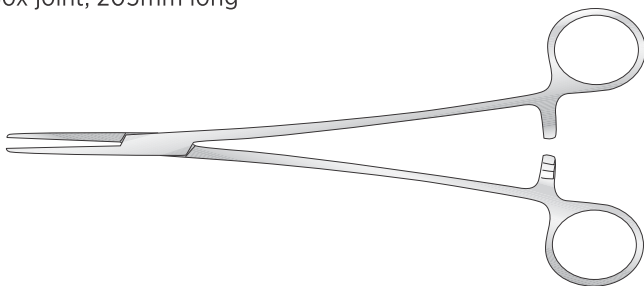

Serrated jaws

Code	Description
Sb-GI/016	Straight
Sb-GI/017	Curved

1-2 teeth

Code	Description
Sb-GI/016a	Straight
Sb-GI/017b	Curved

Kelly Artery Forceps

Box joint, half serrated jaws



Straight

Code	Description
Sb-GI/022	140mm long
Sb-GI/023	160mm long

Curved

Code	Description
Sb-GI/024	140mm long
Sb-GI/025	160mm long

Fraser Kelly Artery Forceps Curved

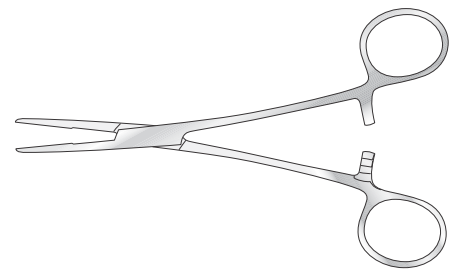

Straight

Code	Description
Sb-GI/468a	180mm

Kocher Artery Forceps

Box joint, 1-2 teeth

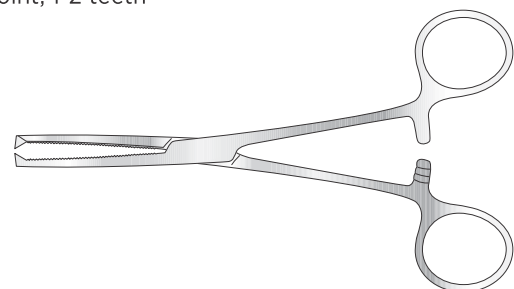

Straight

Code	Description
Sb-GI/052	130mm long
Sb-GI/053	150mm long
Sb-GI/054	180mm long
Sb-GI/055	200mm long
Sb-GI/056	230mm long

Curved

Code	Description
Sb-GI/057	150mm long
Sb-GI/058	180mm long
Sb-GI/059	200mm long
Sb-GI/060	230mm long

CLAMPS



Dieffenbach Bulldog Clamp

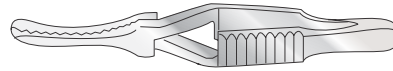
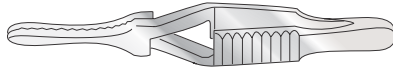

Straight, serrated

Code	Description
Sb-GI/112	1.2mm fine jaw, 40mm long
Sb-GI/113	1.2mm fine jaw, 45mm long
Sb-GI/108	1.8mm jaw, 30mm long
Sb-GI/109	1.8mm jaw, 35mm long
Sb-GI/110	2.5mm jaw, 40mm long
Sb-GI/111	2.5mm jaw, 45mm long
Sb-GI/107	6mm heavy jaw, 60mm long
Sb-GI/455	20mm jaw, 75mm long
Sb-GI/455a	30mm jaw, 85mm long
Sb-GI/455b	45mm jaw, 105mm long
Sb-GI/455c	65mm jaw, 120mm long

Straight, plain

Code	Description
Sb-GI/129	1.2mm fine jaw, 40mm long
Sb-GI/131	1.2mm fine jaw, 45mm long
Sb-GI/121	1.8mm jaw, 30mm long
Sb-GI/123	1.8mm jaw, 35mm long
Sb-GI/125	2.5mm jaw, 40mm long
Sb-GI/127	2.5mm jaw, 45mm long

Curved, serrated

Code	Description
Sb-GI/119	1.2mm fine jaw, 40mm long
Sb-GI/120	1.2mm fine jaw, 45mm long
Sb-GI/115	1.8mm jaw, 30mm long
Sb-GI/116	1.8mm jaw, 35mm long
Sb-GI/117	2.5mm jaw, 40mm long
Sb-GI/118	2.5mm jaw, 45mm long
Sb-GI/114	6mm heavy jaw, 60mm long
Sb-GI/456	20mm jaw, 75mm long
Sb-GI/456a	30mm jaw, 85mm long
Sb-GI/456b	45mm jaw, 105mm long
Sb-GI/456c	65mm jaw, 120mm long

Curved, plain

Code	Description
Sb-GI/130	1.2mm fine jaw, 40mm long
Sb-GI/132	1.2mm fine jaw, 45mm long
Sb-GI/122	1.8mm jaw, 30mm long
Sb-GI/124	1.8mm jaw, 35mm long
Sb-GI/126	2.5mm jaw, 40mm long
Sb-GI/128	2.5mm jaw, 45mm long

Blalock Bulldog Clamp

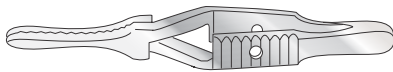

Serrated, with hole in handle

Straight

Code	Description
Sb-GI/480	11mm jaw, 38mm long
Sb-GI/482	14mm jaw, 48mm long
Sb-GI/493	17mm jaw, 60mm long
Sb-GI/481	27mm jaw, 70mm long

Curved

Code	Description
Sb-GI/478	11mm jaw, 38mm long
Sb-GI/479	14mm jaw, 48mm long
Sb-GI/491	17mm jaw, 60mm long
Sb-GI/492	27mm jaw, 70mm long

Plain, with hole in handle

Straight

Code	Description
Sb-GI/486	11mm jaw, 38mm long
Sb-GI/487	14mm jaw, 48mm long
Sb-GI/488	17mm jaw, 60mm long
Sb-GI/489	27mm jaw, 70mm long

Curved

Code	Description
Sb-GI/483	11mm jaw, 38mm long
Sb-GI/484	14mm jaw, 48mm long
Sb-GI/485	17mm jaw, 60mm long
Sb-GI/490	27mm jaw, 70mm long

An Overview On Forcep Jaw Types

You will see that forceps in our catalogue will have either a traditional serrated jaw or a different design which is known as atraumatic (or non-traumatic).

Traditional Serrated Jaw



The traditional serrated jaw is generally more robust and used on forceps where the areas are not as delicate.

Atraumatic Jaw



Atraumatic jaws will be mainly found in delicate surgery areas such as vascular and cardiothoracic. The design is such, that the surface area gripped is reduced, ensuring less trauma without the loss of grip.

SPRING FORCEPS

Adsons Dissecting Forceps

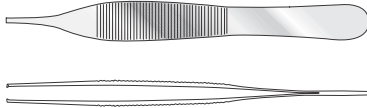

127mm long

Code	Description
Sb-GI/257	1-2 teeth
Sb-GI/258	Lightweight, micro
Sb-GI/259	Serrated
Sb-GI/260	Serrated, lightweight, micro

Block End Dissecting Forceps

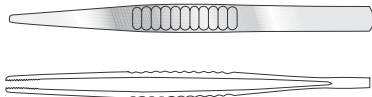

Serrated

Code	Description
Sb-GI/255	127mm long
Sb-GI/256	152mm long
Sb-GI/256a	203mm long

Bonney Dissecting Forceps

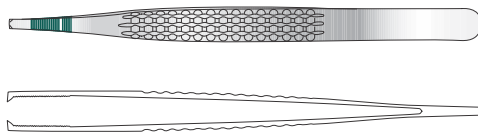

178mm long

Code	Description
Sb-GI/267	Serrated, 1-2 teeth
Sb-GI/268	1-2 teeth

Charnley-McIndoe Dissecting Forceps

150mm long

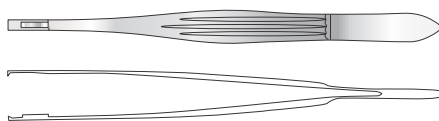

Code	Description
Sb-OR/N045a	2-3 teeth

DeBakey Atraumatic Dissecting Forceps

Straight, atraumatic jaws

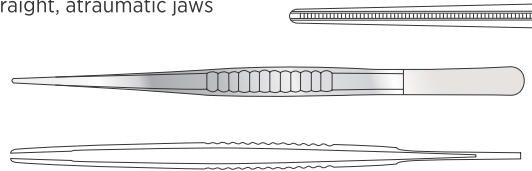

1.5mm

Code	Description
Sb-GI/238a	150mm long
Sb-GI/240a	240mm long

2.5mm

Code	Description
Sb-GI/238b	150mm long
Sb-GI/240b	240mm long

2mm

Code	Description
Sb-GI/238	150mm long
Sb-GI/241	180mm long

2.8mm

Code	Description
Sb-GI/238c	150mm long
Sb-GI/240c	240mm long
Sb-GI/241c	180mm long

Dissecting Forceps

Turnover end, serrated jaws

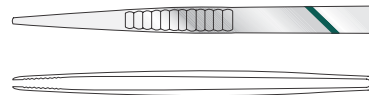

Code	Description
Sb-GI/242	127mm long
Sb-GI/243	152mm long

Code	Description
Sb-GI/244	178mm long
Sb-GI/245	203mm long

Dunhill Dissecting Forceps

Light, fine serrated jaws



Code	Description
Sb-GI/457	145mm long

Fredrick Coole Dissecting Forceps

Extra fine serrated jaws

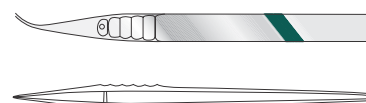

125mm long

Code	Description
Sb-GI/066	Straight
Sb-GI/067	Curved

SPRING FORCEPS



Gillies Dissecting Forceps

1-2 teeth

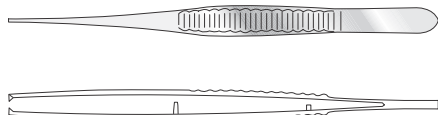

Code	Description
Sb-PL/052	152mm long

McIndoe Dissecting Forceps

152mm long

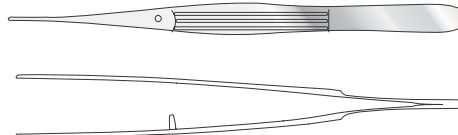

Code	Description
Sb-GI/476	Serrated
Sb-GI/477	1-2 teeth

Jackson Burrows Dissecting Forceps

140mm long

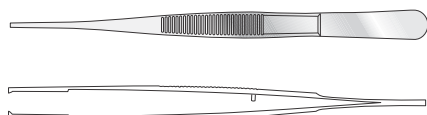

Code	Description
Sb-OR/N037	Tongue and groove, 1-2 teeth
Sb-OR/N037a	Tongue and groove only

McIndoe Modified Dissecting Forceps

152mm long, 1mm tip, modified for fine powerful dissection with strong action tip

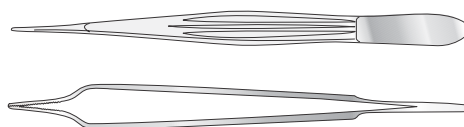

Code	Description
Sb/5961	Serrated

Jean Dissecting Forceps

Serrated jaws, 140mm long

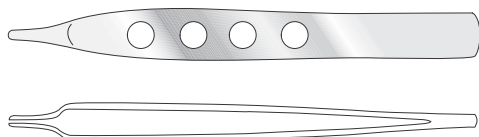

Code	Description
Sb-GI/269	Fine
Sb-GI/270	1-2 teeth
Sb-GI/271	2-3 teeth, 178mm long

Treves Dissecting Forceps

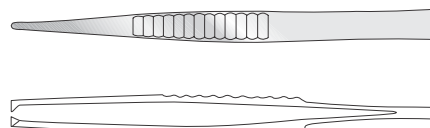

1-2 teeth

Code	Description
Sb-GI/251	127mm long
Sb-GI/252	152mm long

2-3 teeth

Code	Description
Sb-GI/253	127mm long
Sb-GI/254	152mm long

Lanes Dissecting Forceps

1-2 teeth on serrated jaws, 140mm long

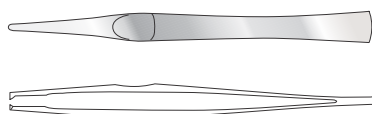

Code	Description
Sb-GI/246	127mm long
Sb-GI/247	152mm long
Sb-GI/248	178mm long

Code	Description
Sb-GI/249	2-3 teeth, 178mm long
Sb-GI/250	2-3 teeth 203mm long

Waugh Dissecting Forceps

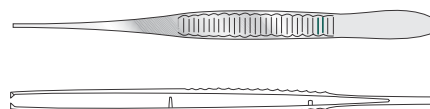

Fine, serrated

Code	Description
Sb-GI/261	152mm long
Sb-GI/262	178mm long
Sb-GI/263	203mm long

Fine, 1-2 teeth

Code	Description
Sb-GI/264	152mm long
Sb-GI/265	178mm long
Sb-GI/266	203mm long

TISSUE FORCEPS

STAHLÉAN BRAZIL
SAVING LIVES



Allis Tissue Forceps

Box joint

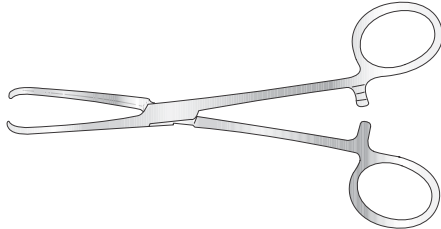

150mm long

Code	Description
Sb-GI/272	3-4 teeth
Sb-GI/273	4-5 teeth

190mm long

Code	Description
Sb-GI/414	5-6 teeth

Duval Tissue Forceps

Box joint

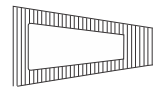
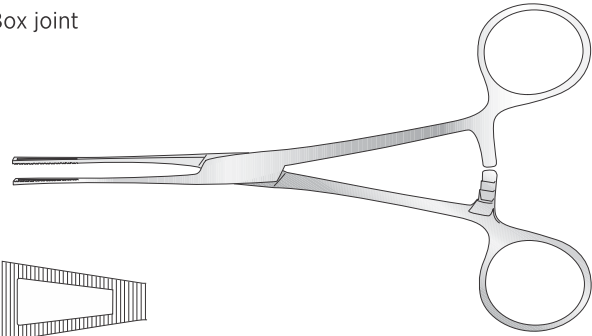

Code	Description
Sb-GI/279	13mm wide, 203mm long

Littlewood Tissue Forceps

Box joint, 2-3 teeth

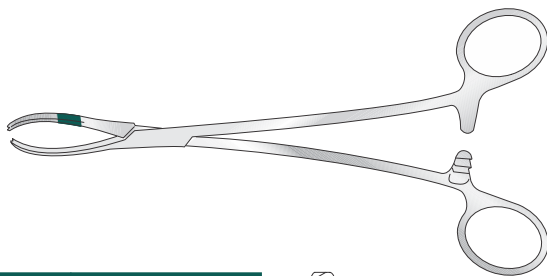

Code	Description
Sb-GI/275	190mm long

Lane Tissue Forceps

Box joint, 1-2 teeth, fenestrated

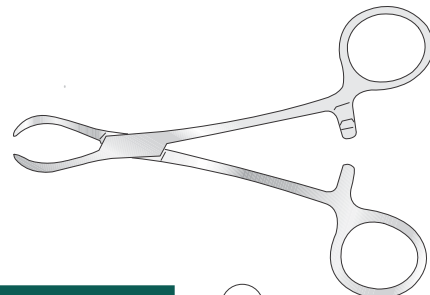

Code	Description
Sb-GI/280	127mm long
Sb-GI/281	152mm long
Sb-GI/282	197mm long

Babcock Tissue Forceps

Box joint, serrated jaws

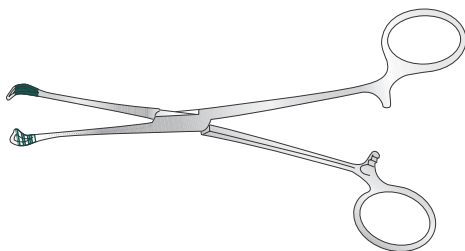

Code	Description
Sb-GI/276	160mm long
Sb-GI/277	200mm long
Sb-GI/278	230mm long

Rutherford Morrison Tissue Forceps

Box joint

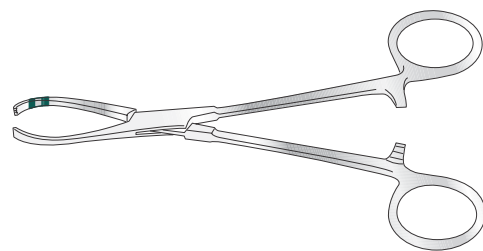

Code	Description
Sb-GI/283	4-5 teeth, 152mm long



TISSUE FORCEPS

STAHLÉAN BRAZIL
SAVING LIVES



Shaw Tissue Forceps

Box joint

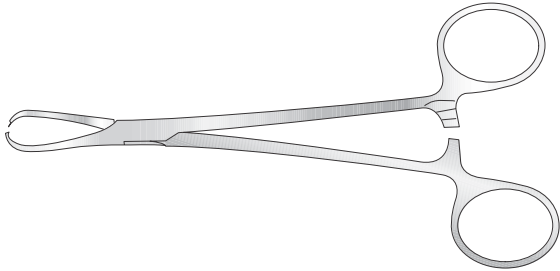

Code	Description
Sb-GI/458	1-2 teeth, 178mm long



Guys Gallabin Suture-Holding Forceps

Screw joint, angled flat blades

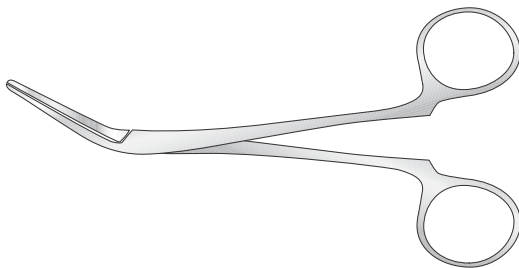

Code	Description
Sb-GI/450	125mm long
Sb-GI/4402	150mm long

Russian Dissecting Forceps

With fenestrated end

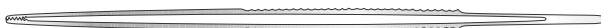

Code	Description
Sb-GI/SH-5503b	150mm long
Sb-GI/SH-5503	200mm long
Sb-GI/403	230mm long
Sb-GI/SH-5503a	250mm long



Special Offer

on SSD Essentials Pack

Top up your trays with these essentials...

Halstead Mosquito Forceps

Straight/Curved
125mm (5")

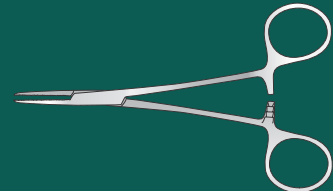

Rampléy Sponge Holding Forceps

Straight, Serrated
Jaws 241mm
(9½")

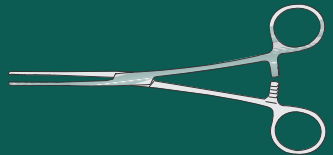

Scalpel Blade Handle

No. 3

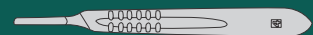

Spring Clip

Serrated Pattern,
Stainless Steel for
Fixing Slings to Leg
Splints, also for
Towel Clipping
6.3cm (2½") Wide

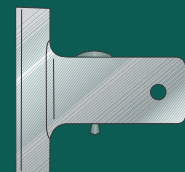

Spencer Wells Artery Forceps

Straight, Serrated
Jaws

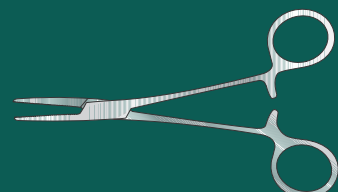

SPONGE HOLDING AND STERILISING FORCEPS



Rampley Sponge Holding Forceps

Box joint, straight, serrated jaws

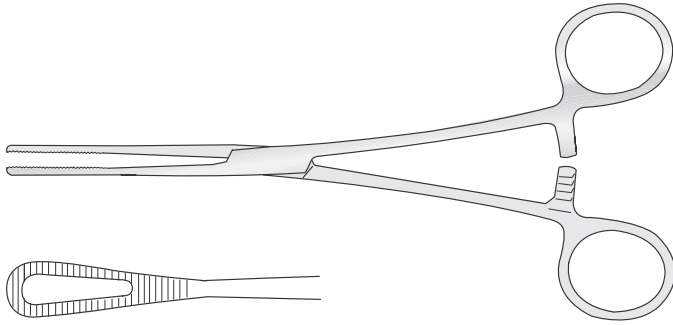

Code	Description
Sb-GI/353	178mm long
Sb-GI/354	241mm long

Lister Sinus Forceps

Box joint, serrated tip

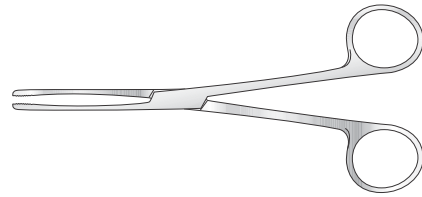

Code	Description
Sb-GI/367	127mm long
Sb-GI/368	152mm long
Sb-GI/369	178mm long

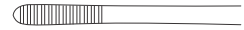

Foerster Sponge Holding Forceps

Box joint, straight, serrated jaws

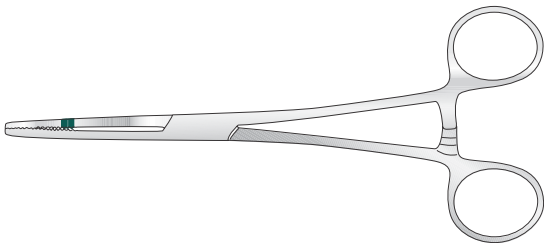

Code	Description
Sb-GI/354a	178mm long

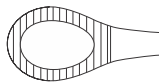

Cheatle Sterilizer Forceps

Screw joint

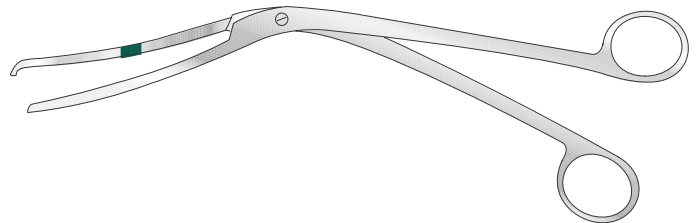

Code	Description
Sb-GI/364	267mm long

Harrison Bowl Steriliser Forceps

Screw joint, angled, double jaw

Code	Description
Sb-GI/365	356mm long
Sb-GI/366	457mm long

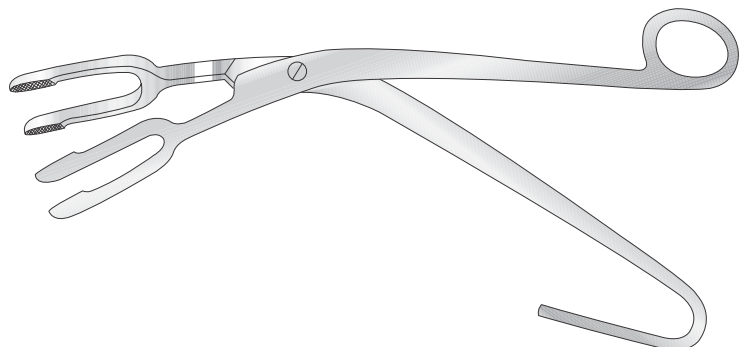

OTHER FORCEPS

STAHLÉAN BRAZIL
SAVING LIVES

Hunter Splinter Forceps

Serrated grooved pointed jaws



Code	Description
Sb-GI/360	115mm long

Michel Forceps

Box joint, double-ended, for inserting and removing clips stainless steel

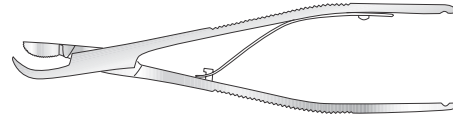

Code	Description
Sb-GI/357	130mm long

Michel Skin Holding Forceps

With magazine for Michel clips

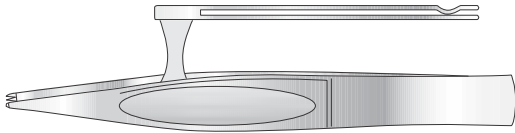

Code	Description
Sb-GI/358	1-2 teeth, 127mm long

Michel Clip Extracting Forceps

Box joint

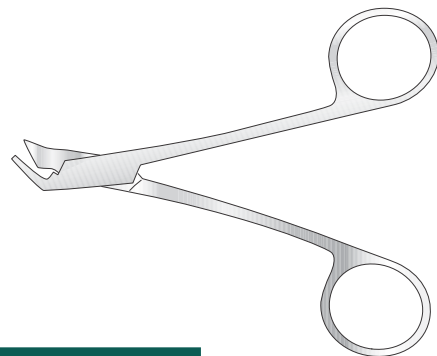

Code	Description
Sb-GI/359	125mm long

Childe Approximating Forceps

With magazine for Michel clips

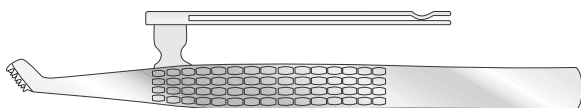

Code	Description
Sb-GI/469	180mm long

Robins Anchoring Forceps

140mm long

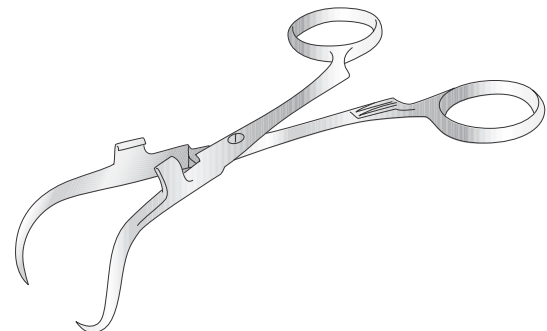

Code	Description
Sb-GI/453	5mm with holder for diathermy leads
Sb-GI/453a	13mm with holder for suction tubing

PREMIUM QUALITY STAINLESS STEEL SCISSORS

STAHLÉAN BRAZIL
SAVING LIVES



Dressing Scissors



Blunt/Blunt

Straight

Code	Description
Sb-GI/133	130mm long
Sb-GI/136	146mm long
Sb-GI/139	165mm long

Curved

Code	Description
Sb-GI/142	130mm long
Sb-GI/143	146mm long
Sb-GI/144	165mm long
Sb-GI/145	185mm long
Sb-GI/404	147mm long

With one serrated blade

Blunt/Sharp

Straight

Code	Description
Sb-GI/134	130mm long
Sb-GI/137	146mm long
Sb-GI/140	165mm long

Sharp/Sharp

Straight

Code	Description
Sb-GI/135	130mm long
Sb-GI/138	146mm long
Sb-GI/141	165mm long

Curved

Code	Description
Sb-GI/146	130mm long

Metzenbaum Scissors

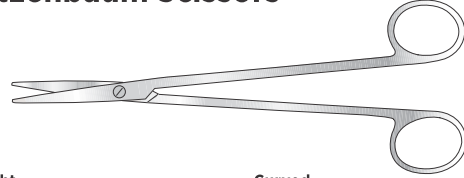

Straight

Code	Description
Sb-GI/405	180mm long
Sb-GI/406	147mm long
Sb-GI/406a	200mm long
Sb-GI/406b	230mm long
Sb-GI/406c	250mm long
Sb-GI/406d	280mm long

Curved

Code	Description
Sb-GI/407	185mm long
Sb-GI/408	147mm long
Sb-GI/408a	200mm long
Sb-GI/408b	230mm long
Sb-GI/408c	250mm long
Sb-GI/408d	280mm long

Dressing Scissors, Left-Handed

With one black bow, 145mm long

Blunt/Blunt

Code	Description
Sb-GI/192	Straight
Sb-GI/193	Curved

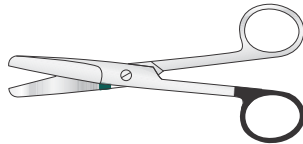

Blunt/Sharp

Code	Description
Sb-GI/194	Straight
Sb-GI/195	Curved

Sharp/Sharp

Code	Description
Sb-GI/196	Straight
Sb-GI/197	Curved

Little Dissecting Scissors

Fine pattern, with eye for suture

Code	Description
Sb-PL/001f	115mm long

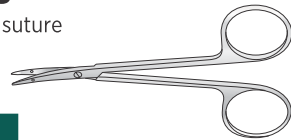

Kilner Dissecting Scissors

Fine pattern

Code	Description
Sb-PL/001a	115mm long

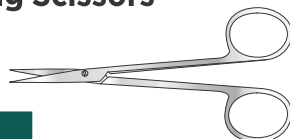

Mayo Scissors



Straight

Code	Description
Sb-GI/409	140mm long
Sb-GI/409a	160mm long
Sb-GI/411	190mm long
Sb-GI/411a	230mm long

Curved

Code	Description
Sb-GI/410	140mm long
Sb-GI/410a	160mm long
Sb-GI/412	190mm long
Sb-GI/412a	230mm long

Fergusson Scissors

Angled on flat

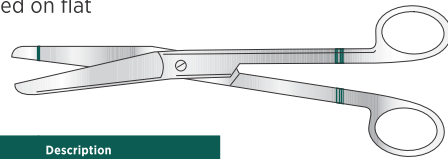

Code	Description
Sb-GI/148	180mm long

Paynes Suture Scissors

Code	Description
Sb-GI/152	100mm long

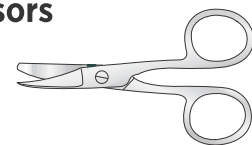

Ligature Stitch Scissors

Fine pattern

Code	Description
Sb-GI/153	115mm long

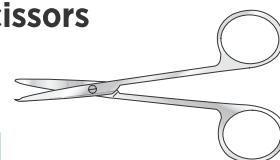

SCISSORS

STAHLÉAN BRAZIL
SAVING LIVES



Lister Bandage Scissors

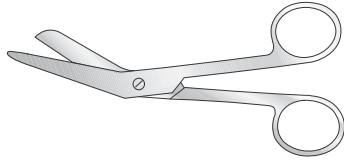

Code	Description
Sb-GI/154	147mm long
Sb-GI/155	178mm long

Lister Bandage Scissors

Angled, with probe end

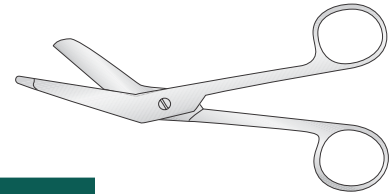

Code	Description
Sb-GI/361	147mm long
Sb-GI/362	178mm long

McIndoe Scissors

178mm long

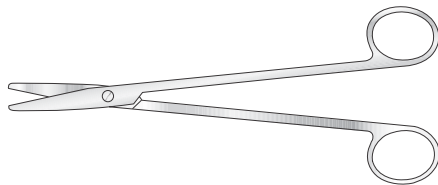

Code	Description
Sb-GI/149	Straight
Sb-GI/150	Curved on flat
Sb-GI/150sc	Supercut, curved



Thomas Strabismus Scissors

114mm long

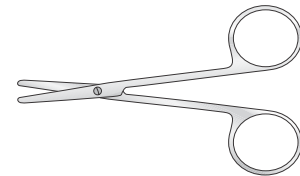

Code	Description
Sb-OP/030	Straight
Sb-OP/029	Curved

Heath Stitch Scissors

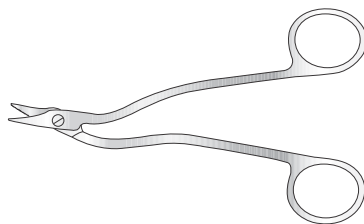

Code	Description
Sb-GI/151	152mm long

“Careless” Scissors

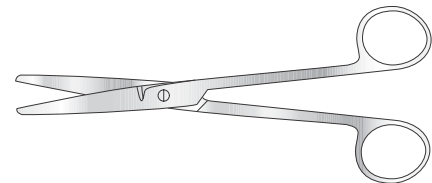

Code	Description
Sb-GI/474	165mm long

Tubing Scissors

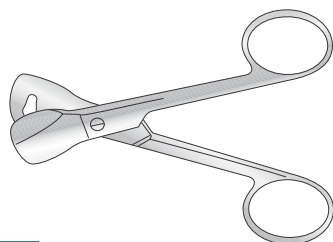

Code	Description
Sb-GI/147	130mm long

Utility Scissors



Code	Description
Sb-GI/466	190mm long

TUNGSTEN CARBIDE HARD INSERT SCISSORS

STAHLÉAN BRAZIL
SAVING LIVES



Dressing Scissors

Tungsten carbide hard insert, blunt/blunt

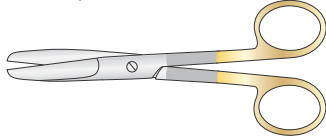

Straight

Code	Description
Sb-GI/430	130mm long
Sb-GI/432	145mm long
Sb-GI/434	165mm long
Sb-GI/436	185mm long

Curved

Code	Description
Sb-GI/431	130mm long
Sb-GI/433	145mm long
Sb-GI/435	165mm long

Mayo Dressing Scissors

Tungsten carbide hard insert

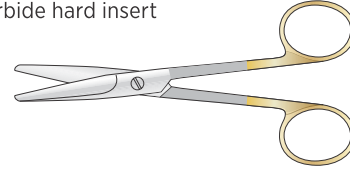

Straight

Code	Description
Sb-GI/419	140mm long
Sb-GI/419a	160mm long
Sb-GI/421	190mm long
Sb-GI/421a	230mm long

Curved

Code	Description
Sb-GI/420	140mm long
Sb-GI/420a	160mm long
Sb-GI/422	190mm long
Sb-GI/422a	230mm long

Dressing Scissors

Tungsten carbide hard insert, blunt/sharp

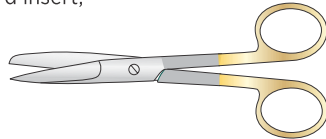

Straight

Code	Description
Sb-GI/423	130mm long
Sb-GI/425	145mm long
Sb-GI/427	165mm long
Sb-GI/429	185mm long

Curved

Code	Description
Sb-GI/424	130mm long
Sb-GI/426	145mm long
Sb-GI/428	165mm long

Mayo-Harrington Dressing Scissors

Tungsten carbide hard insert

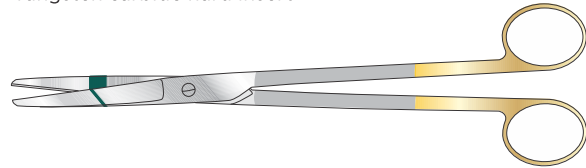

230mm long

Code	Description
Sb-GI/417	Straight
Sb-GI/418	Curved

200mm long

Code	Description
Sb-GI/162a	Straight
Sb-GI/413b	Curved

Dressing Scissors

Tungsten carbide hard insert sharp/sharp

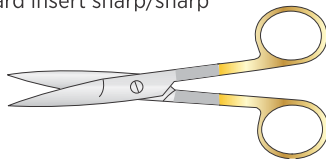

Straight

Code	Description
Sb-GI/437	130mm long
Sb-GI/439	145mm long
Sb-GI/441	165mm long
Sb-GI/443	185mm long

Curved

Code	Description
Sb-GI/438	130mm long
Sb-GI/440	145mm long
Sb-GI/442	165mm long

Metzenbaum Scissors

Tungsten carbide hard insert

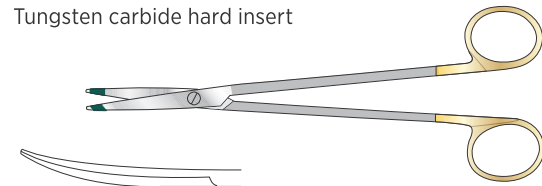

230mm long

Code	Description
Sb-GI/445	145mm long
Sb-GI/448	185mm long
Sb-GI/471a	230mm long
Sb-GI/471b	250mm long
Sb-GI/471c	280mm long

200mm long

Code	Description
Sb-GI/446	145mm long
Sb-GI/449	185mm long
Sb-GI/449a	200mm long
Sb-GI/449b	230mm long
Sb-GI/449c	250mm long
Sb-GI/449d	280mm long

Baby Metzenbaum Scissors

Tungsten carbide, hard insert, 145mm long

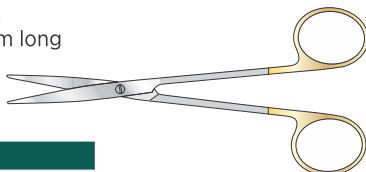

Code	Description
Sb-GI/445a	Straight
Sb-GI/446a	Curved

Ligature Scissors

Tungsten carbide hard insert, curved

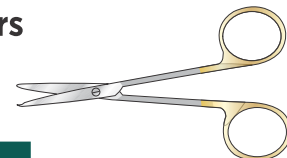

Code	Description
Sb-GI/444	145mm long
Sb-GI/447	185mm long

TUNGSTEN CARBIDE SUPERCUT SCISSORS

STAHLÉAN BRAZIL
SAVING LIVES



Mayo Harrington Scissors

Supercut, tungsten carbide

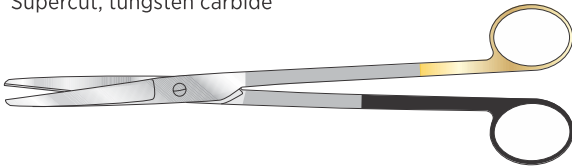

230mm long

Code	Description
Sb-GI/162	Straight
Sb-GI/413	Curved

200mm long

Code	Description
Sb-GI/162b	Straight
Sb-GI/413b	Curved

Dressing Scissors

Supercut, tungsten carbide

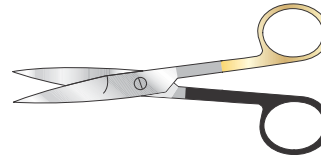

Blunt/Blunt

Straight

Code	Description
Sb-GI/174	130mm long
Sb-GI/176	145mm long
Sb-GI/178	165mm long
Sb-GI/180	185mm long

Curved

Code	Description
Sb-GI/175	130mm long
Sb-GI/177	145mm long
Sb-GI/179	165mm long
Sb-GI/180a	185mm long

Mayo Scissors

Supercut, tungsten carbide

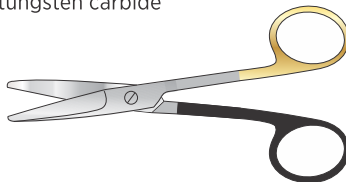

Straight

Code	Description
Sb-GI/163	140mm long
Sb-GI/163a	160mm long
Sb-GI/165	190mm long
Sb-GI/165a	230mm long

Curved

Code	Description
Sb-GI/164	140mm long
Sb-GI/164a	160mm long
Sb-GI/166	190mm long
Sb-GI/166a	230mm long

Blunt/Sharp

Straight

Code	Description
Sb-GI/167	130mm long
Sb-GI/169	145mm long
Sb-GI/171	165mm long
Sb-GI/173	185mm long

Curved

Code	Description
Sb-GI/168	130mm long
Sb-GI/170	145mm long
Sb-GI/172	165mm long
Sb-GI/173a	185mm long

Sharp/Sharp

Straight

Code	Description
Sb-GI/181	130mm long
Sb-GI/183	145mm long
Sb-GI/185	165mm long
Sb-GI/187	185mm long

Curved

Code	Description
Sb-GI/182	130mm long
Sb-GI/184	145mm long
Sb-GI/186	165mm long
Sb-GI/187a	185mm long

Metzenbaum Dissecting Scissors

Supercut, tungsten carbide

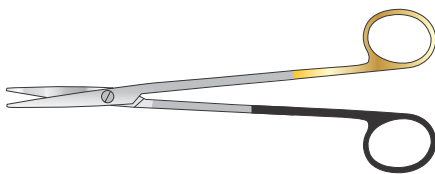

Straight

Code	Description
Sb-GI/188tc	185mm long
Sb-GI/188tca	200mm long
Sb-GI/188tcb	230mm long
Sb-GI/188tcc	250mm long
Sb-GI/188tcd	280mm long

Curved

Code	Description
Sb-GI/191tc	147mm
Sb-GI/189tc	185mm
Sb-GI/186tca	200mm
Sb-GI/188tcb	230mm
Sb-GI/188tcc	250mm
Sb-GI/188tcd	280mm

Guide for Gold and Black Bows

It's important to know the difference for the intended use of each scissor:



2 Gold Bows
Tungsten carbide insert or padding for a scissor



2 Black Bows
Supercut edge



1 Black and 1 Gold Bow
Supercut tungsten carbide



1 Black Bow (left ring)
Left-handed instrument carbide

SUPERCUT OPERATING SCISSORS

STAHLÉAN BRAZIL
SAVING LIVES



Dressing Scissors

Supercut, blunt/blunt



145mm long

Code	Description
Sb-GI/160	Straight
Sb-GI/161	Curved

Dressing Scissors

Supercut, blunt/sharp

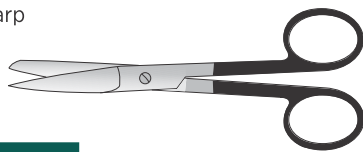

145mm long

Code	Description
Sb-GI/156	Straight
Sb-GI/157	Curved

Dressing Scissors

Supercut, sharp/sharp



145mm long

Code	Description
Sb-GI/158	Straight
Sb-GI/159	Curved

Mayo Scissors

Supercut

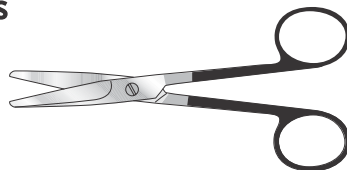

Straight

Code	Description
Sb-GI/166a	140mm long
Sb-GI/166e	160mm long
Sb-GI/166b	170mm long

Curved

Code	Description
Sb-GI/166c	140mm long
Sb-GI/166f	160mm long
Sb-GI/166d	170mm long

Boyd Scissors

Supercut, blunt/blunt

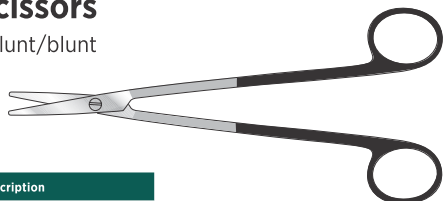

Code	Description
Sb-THO/047	180mm long

Metzenbaum Dissecting Scissors

Supercut

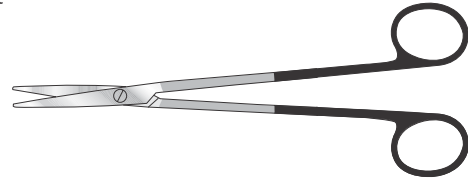

Straight (length)

Code	Description
Sb-GI/190	147mm
Sb-GI/188	185mm
Sb-GI/188a	200mm
Sb-GI/188b	230mm
Sb-GI/188c	250mm
Sb-GI/188d	280mm

Curved (length)

Code	Description
Sb-GI/191	147mm
Sb-GI/189	185mm
Sb-GI/186a	200mm
Sb-GI/186b	230mm
Sb-GI/186c	250mm
Sb-GI/186d	280mm

Stevens Tenotomy Scissors

Supercut

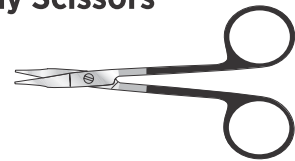

Curved/blunt

Code	Description
Sb-OP/424	114mm long
Sb-OP/424a	125mm long
Sb-OP/424gb	135mm long

Curved/sharp

Code	Description
Sb-OP/425	114mm long
Sb-OP/425a	140mm long
Sb-OP/425b	160mm long

With cutout, 110mm long

Code	Description
Sb-OP/426	Straight/blunt, 114mm long
Sb-OP/427	Straight/sharp, 114mm long
Sb-OP/427c	Straight/sharp, 180mm long

Code	Description
Sb-OP/427a	Straight/blunt
Sb-OP/427b	Curved/blunt

Strabismus Scissors

Supercut

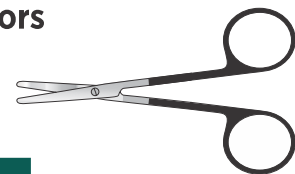

114mm long

Code	Description
Sb-GI/475	Straight
Sb-GI/475a	Curved

Iris Scissors

Supercut

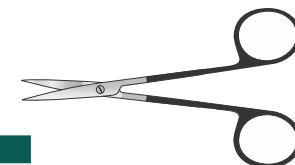

114mm long

Code	Description
Sb-OP/476	Straight
Sb-OP/476a	Curved

NEEDLE HOLDERS

STAHLÉAN BRAZIL
SAVING LIVES



Bruce Clarke Needle Holder

Screw joint

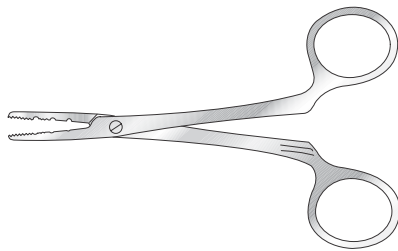

Code	Description
Sb-GI/205	127mm long

Lawrence Needle Holder

Fine jaw, 150mm long

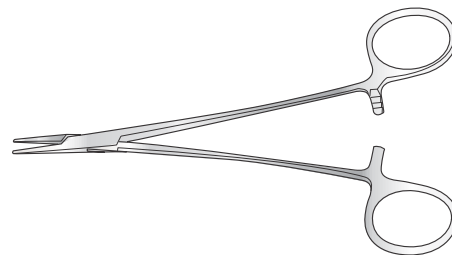

Code	Description
Sb-PL/012a	
Sb-PL/012b	Tungsten carbide jaw

Crile-Wood Needle Holder

Straight, baby, fine

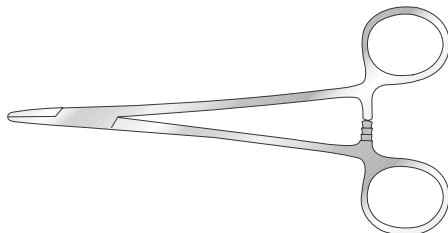

Code	Description
Sb-GI/199	150mm long

Needle Holder

Surgical Holdings pattern, box joint, lightweight, with curved plain jaws and one offset bow for thumb

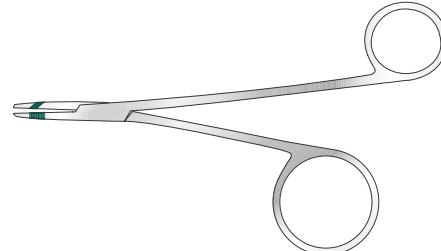

Code	Description
Sb-GI/209	152mm long

Kilner Needle Holder

Box joint, cross-serrated jaw

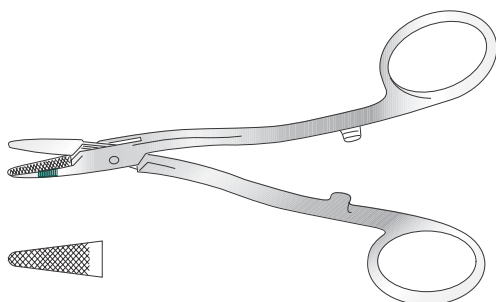

Code	Description
Sb-GI/200	165mm long
Sb-GI/201	133mm long

MacPhail Needle Holder

Screw joint, with one copper jaw

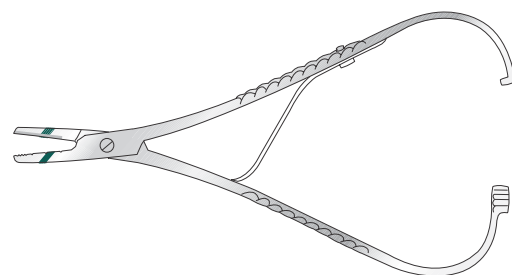

Code	Description
Sb-GI/206	159mm long
Sb-GI/207	178mm long
Sb-GI/208	209mm long

NEEDLE HOLDERS

STAHLÉAN BRAZIL
SAVING LIVES



Mathieu Needle Holder

Screw joint

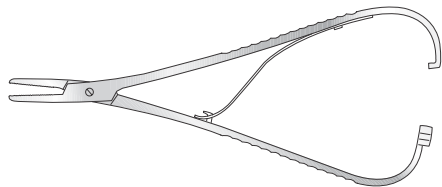

Code	Description
Sb-GI/210	172mm long
Sb-GI/211	209mm long
Sb-GI/212	243mm long

Naughton Morgan Needle Holder

Box joints, cross serrated jaws

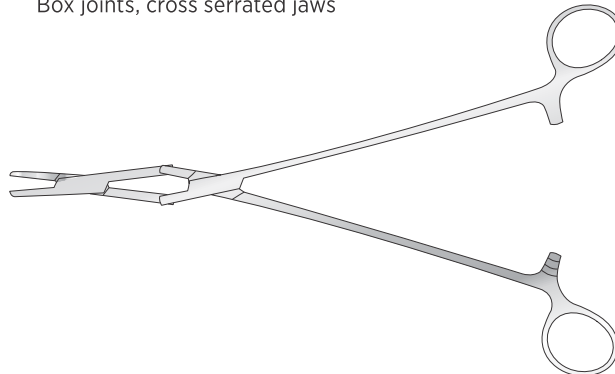

Mayo Needle Holder

Box joint, straight

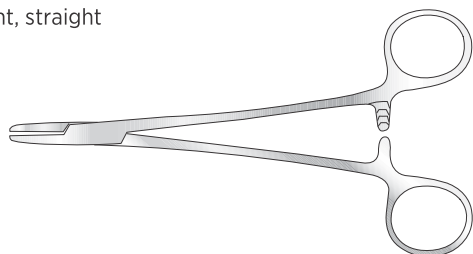

Wide cross serrated jaws

Code	Description
Sb-GI/224	159mm long
Sb-GI/398	203mm long



Narrow cross serrated jaws

Code	Description
Sb-GI/225	159mm long

Tungsten carbide

Code	Description
Sb-GI/399	185mm long
Sb-GI/400	254mm long

Code	Description
Sb-GI/401	185mm long
Sb-GI/402	254mm long

Rochester-Mayo Needle Holder

Screw joint

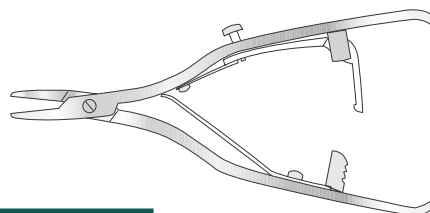

Code	Description
Sb-GI/213	178mm long

Choosing the most suitable needle size

Our tungsten carbide inserts are available in a variety of styles. Choosing the most suitable needle size for each procedure helps give the surgeon maximum grip and control.

Coarse 0.65mm

For powerful needle holder patterns and wire twisters. Maximum holding capabilities for heavy needles or wire.



Standard 0.5mm

Used, for example, in Mayo-Hegar, Mathieu Needle Holders. For needles 3-0 and larger.



Fine 0.4mm

For delicate needle holders such as Crile-Wood and DeBakey. For needles and sutures between 4-0 and 6-0.



Micro 0.2-0.3mm

For micro needle holders such as Castroviejo, Microvascular and Mini-Ryder. For delicate needles and sutures between 7-0 and 10-0.



Smooth

Smooth tungsten carbide surface reduces damage to delicate needles and suture of 6-0 and finer.



TUNGSTEN CARBIDE NEEDLE HOLDERS

Berry Needle Holder/Wire Twister

Tungsten carbide jaws

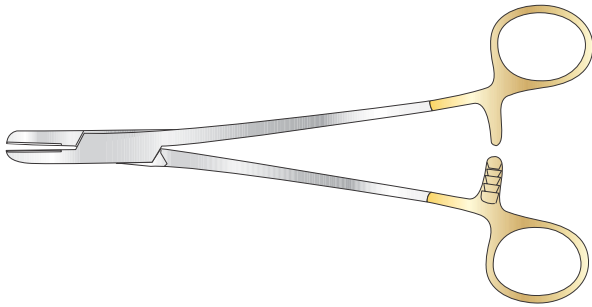

Code	Description
Sb-GI/467	200mm long

Finochietto Needle Holder

Tungsten carbide jaws

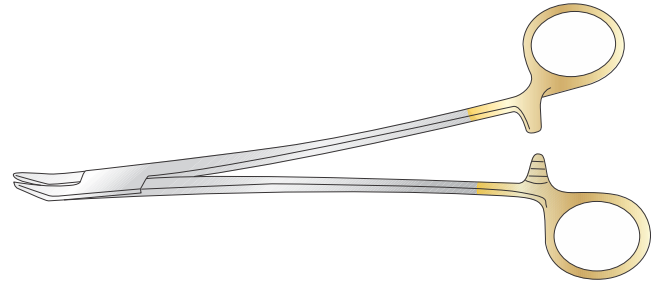

Code	Description
Sb-GI/222	215mm long
Sb-GI/223	265mm long

Crile-Wood Needle Holder

Tungsten carbide insert, box joint, satin finish, straight

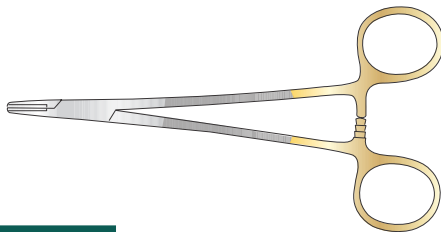

Code	Description
Sb-GI/217	159mm long
Sb-GI/218	178mm long
Sb-GI/198	150mm long

Halsey Needle Holder

Tungsten carbide insert, box joint, satin finish, straight

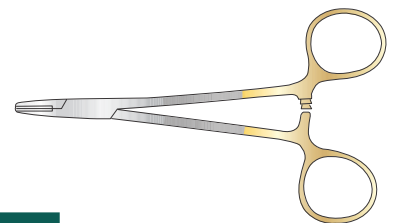

Code	Description
Sb-GI/220	127mm long

Derf Needle Holder

Tungsten carbide insert

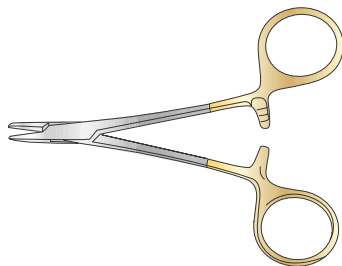

Code	Description
Sb-GI/BUPHF002	115mm long

Kilner Needle Holder

Tungsten carbide insert

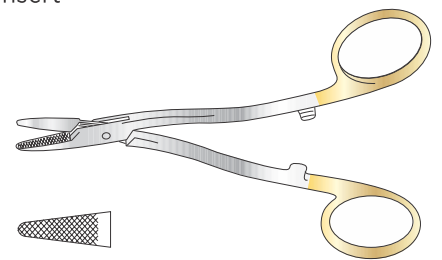

Code	Description
Sb-GI/221	140mm long



TUNGSTEN CARBIDE NEEDLE HOLDERS

Masing Needle Holder

Tungsten carbide insert, one angled bow

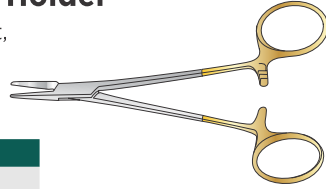

Code	Description
Sb-GI/009R	130mm long

Nievert Needle Holder

Tungsten carbide insert, box joint, satin finish, straight

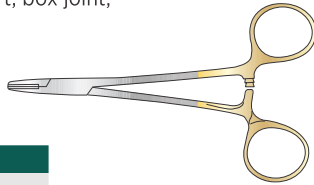

Code	Description
Sb-GI/219	127mm long

DeBakey Needle Holder

250mm long

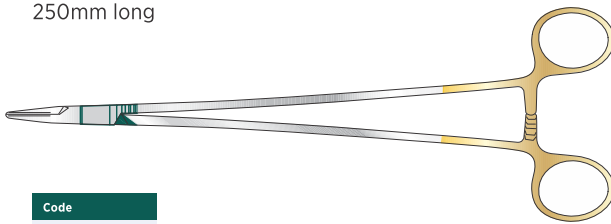

Code
THO/ SI-5642a

Ryder Needle Holder

Tungsten carbide insert, box joint, satin finish, straight

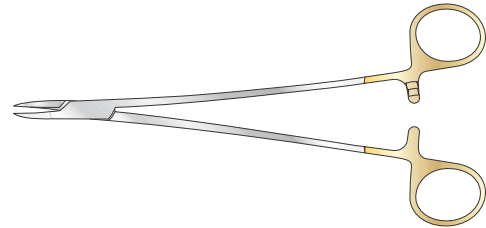

0.2mm jaw pitch

Code	Description
Sb-GI/SH-5197a	135mm long
Sb-GI/SH-5197b	155mm long
Sb-GI/SH-5197c	175mm long
Sb-GI/SH-5197d	210mm long

0.4mm jaw pitch

Code	Description
Sb-GI/SH-5198a	135mm long
Sb-GI/SH-5198b	155mm long
Sb-GI/SH-5198c	175mm long
Sb-GI/SH-5198d	210mm long

Sarot Needle Holder

Diamond jaw, tungsten carbide, gold plated bows

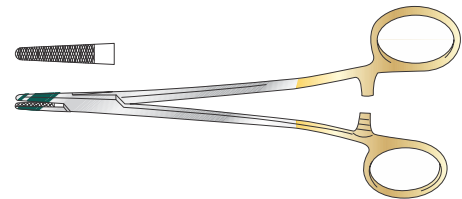

Code	Description
Sb-GI/451	181mm long

Tungsten Carbide Needle Holders

Features and Benefits

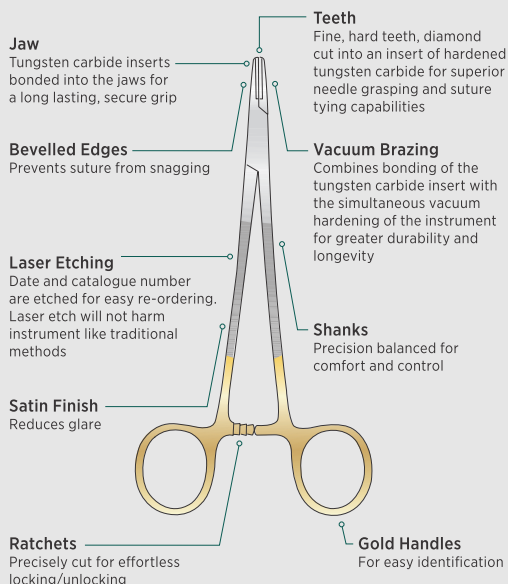

Mayo-Hegar Needle Holder

Tungsten carbide insert, box joint, satin finish, straight

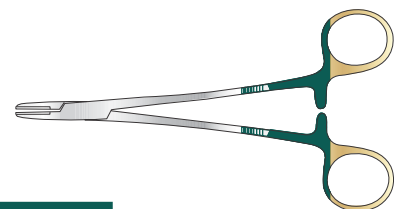

Code	Description
Sb-GI/472	130mm long
Sb-GI/214	159mm long
Sb-GI/215	178mm long
Sb-GI/216	209mm long

LONGER SIZES AVAILABLE

COMBINED SCISSOR AND NEEDLE HOLDERS

STAHLÉAN BRAZIL
SAVING LIVES



Olsen-Hegar Scissor/Needle Holder

With tungsten carbide insert

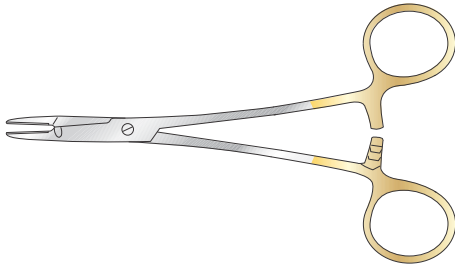

Code	Description
Sb-GI/229	147mm long
Sb-GI/230	165mm long

Olsen-Hegar Scissor/Needle Holder

Screw joint

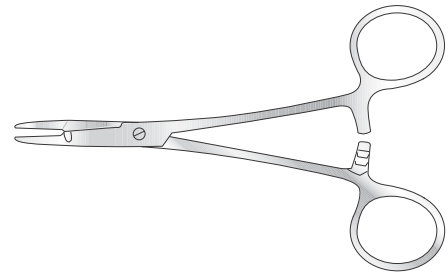

Code	Description
Sb-GI/226	140mm long
Sb-GI/227	165mm long
Sb-GI/228	190mm long

Gillies Scissor/Needle Holder

Right-hand, with tungsten carbide insert

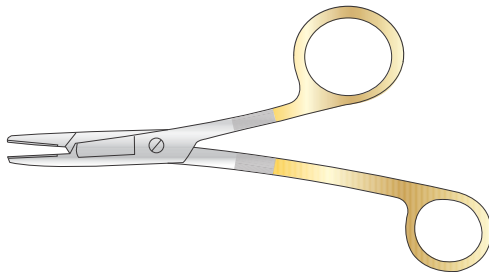

Code	Description
Sb-GI/235	158mm long

Gillies Scissor/Needle Holder

Heavy pattern, 158mm long



Code	Description
Sb-GI/233	Right-hand
Sb-GI/234	Left-hand

Gillies Scissor/Needle Holder

158mm long

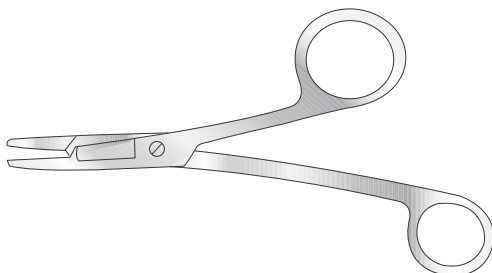

Code	Description
Sb-GI/231	Right-hand
Sb-GI/232	Left-hand

Foster Gillies Scissor/Needle Holder

Fine pattern

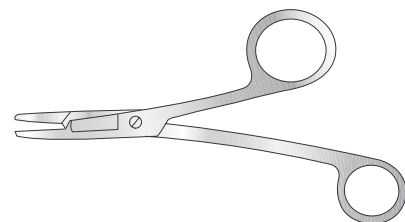

Code	Description
Sb-GI/236	127mm long

RONGEURS

STAHLÉAN BRAZIL
SAVING LIVES



Beck Rongeur

Straight, for intervertebral disc

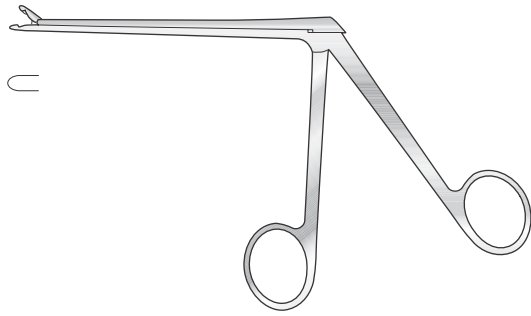

Code	Description
Sb-NEU/125	2mm bite, 130mm shaft

Pennybacker Rongeur

120mm shaft

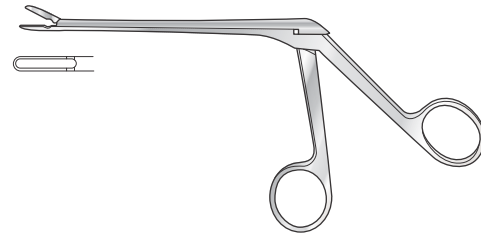

Code	Description
Sb-NEU/133	3mm bite
Sb-NEU/107	4mm bite

Cushing Rongeur

130mm shaft



Code	Description
Sb-NEU/127-2	2mm bite
Sb-NEU/127-3	3mm bite
Sb-NEU/127-4	4mm bite
Sb-NEU/127-5	5mm bite
Sb-NEU/127-6	6mm bite



St Bart's Rongeur

114mm shaft

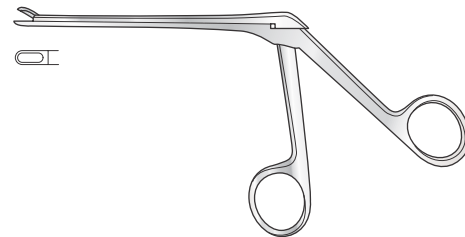

Code	Description
Sb-ENT/140a	3mm bite

Cushing Rongeur

130mm shaft

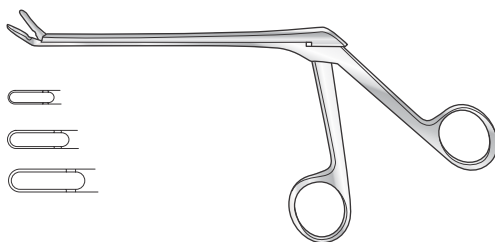

150° upward cutting

Code	Description
Sb-NEU/128c	2mm bite
Sb-NEU/128	3mm bite
Sb-NEU/128a	4mm bite
Sb-NEU/128b	5mm bite

150° downward cutting

Code	Description
Sb-NEU/130c	2mm bite
Sb-NEU/130	3mm bite
Sb-NEU/130a	4mm bite
Sb-NEU/130b	5mm bite

St Bart's Rongeur

140°, 3mm, 114mm shaft

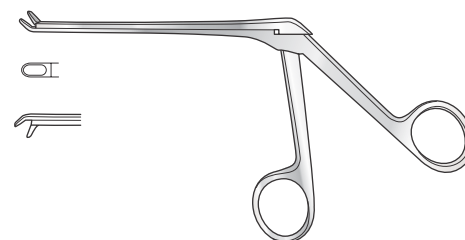

Code	Description
Sb-ENT/140b	Upward cutting
Sb-ENT/140ac	Downward cutting

BAG AND TOWEL CLIPS

STAHLÉAN BRAZIL
SAVING LIVES



Spring Clip

Serrated pattern, stainless steel, for fixing slings to leg splints, also for towel clipping

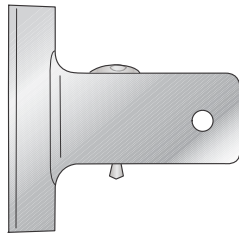

Code	Description
Sb-GI/344	63mm wide

Spring Bag Clip

Serrated

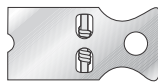

Code	Description
Sb-GI/345	26mm wide

Jones Towel Clip

Superior quality spring forcep type

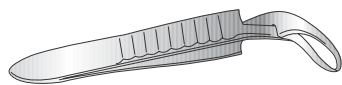

Code	Description
Sb-GI/346	89mm long

Shardles Towel Clip

Spring curved, cross action

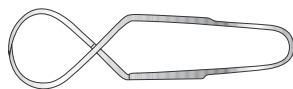

Code	Description
Sb-GI/347	77mm long

Backhaus Towel Clip

Superior quality, box joint

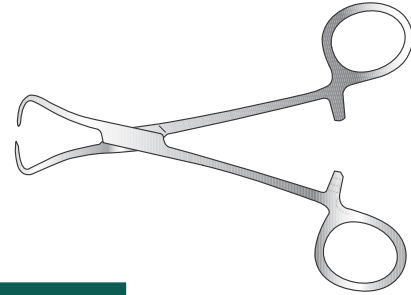

Code	Description
Sb-GI/348	89mm long
Sb-GI/348a	102mm long
Sb-GI/349	130mm long

Moynihan Towel Clip

Screw joint, 2-2 teeth, for sides of incision

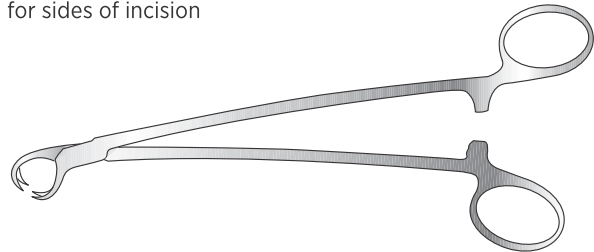

Code	Description
Sb-GI/470	191mm long

Ball and Socket Towel Forceps

Box joint

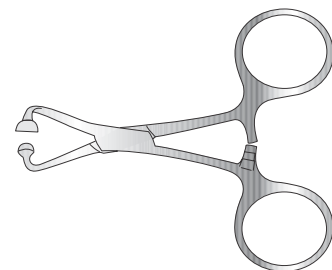

Code	Description
Sb-GI/350	89mm long
Sb-GI/351	115mm long
Sb-GI/352	140mm long

RETRACTORS

STAHLÉAN BRAZIL
SAVING LIVES



Goligher Retractor

Complete with 2 centre blades:
1 x 90mm wide x 50mm deep
1 x 90mm wide x 90mm deep

and 2 pairs of lateral blades:
1 pair 25mm wide x 45mm deep
1 pair 50mm wide x 90mm deep

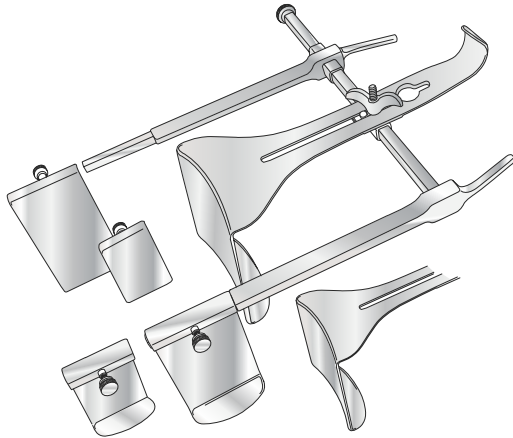

Code

Sb-GI/305

Balfour Abdominal Retractor

Trivalve, frame 203mm

Child

102mm opening, 51mm deep lateral blades,
38mm deep centre blade

Adult

178mm opening, 64mm deep lateral blades,
44mm deep centre blade

Extra large

178mm opening, 102mm deep lateral blades,
108mm deep centre blade

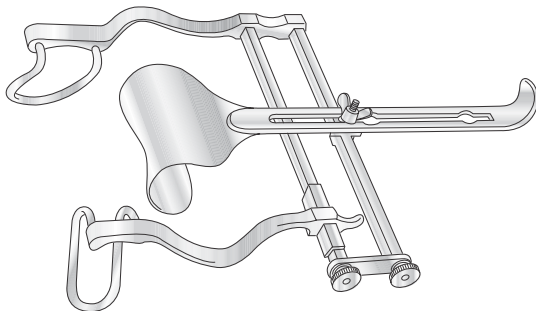

Code

Code	Description
Sb-GI/373	Child
Sb-GI/374	Adult
Sb-GI/375	Extra large

Miles Retractor

Complete with 2 centre blades:
1 x 90mm wide x 50mm deep
1 x 90mm wide x 75mm deep

and 2 pairs of lateral blades:
1 pair 80mm wide x 35mm deep
1 pair 80mm wide x 75mm deep

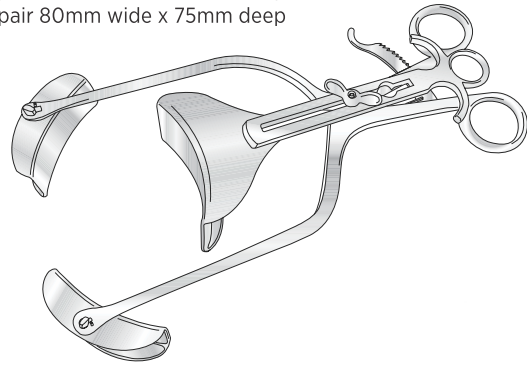

Code

Code	Description
Sb-GI/376	340mm long

OTHER BLADE SIZES AVAILABLE

Balfour Abdominal Retractor

Bivalve, baby

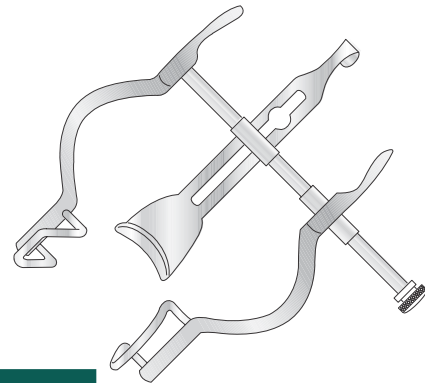

Code

Code	Description
Sb-GI/372	Fully open 89mm

Berkeley Abdominal Retractor

Parallel action

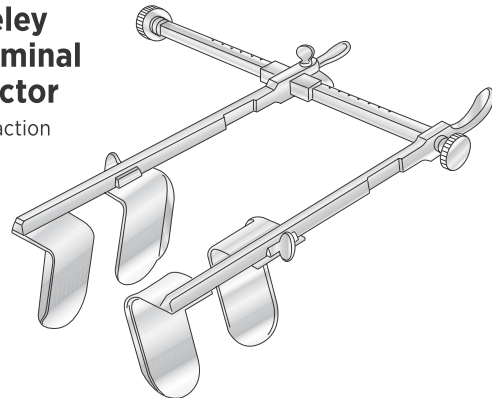

Code

Code	Description
Sb-GI/461	Blades 35mm x 60mm deep, 215mm long

TURNER WARWICK RETRACTORS

STAHLÉAN BRAZIL
SAVING LIVES



Turner Warwick Universal Self Retaining Retractor

Code	Description
Sb-GI/520	With frames A/B/C/D and blades A/B/C/D/E/F/K/L
Sb-GI/521-A	Circular frame A only 178mm
Sb-GI/521-B	Circular frame B only 229mm
Sb-GI/521-C	Circular frame C only 305mm
Sb-GI/521-D	Oval frame D only 475mm x 330mm
Sb-GI/521-E	Oval frame E only 370mm x 300mm

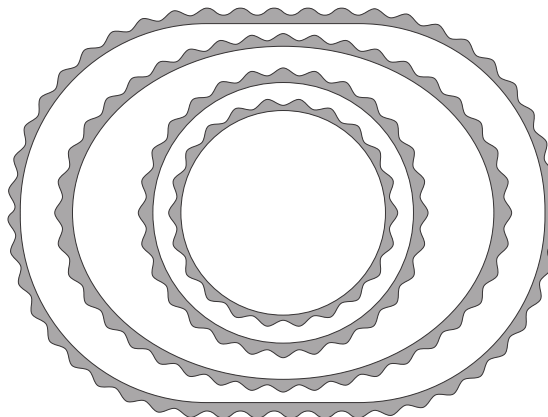

Turner Warwick Needleholder with Tungsten Carbide Jaws

Curved shanks with one short bow

Code	Description
Sb-5835	230mm long
Sb-5835A	200mm long

Blade A



Code	Description
Sb-GI/522-A	Blade only - 19mm x 76mm

Blade B

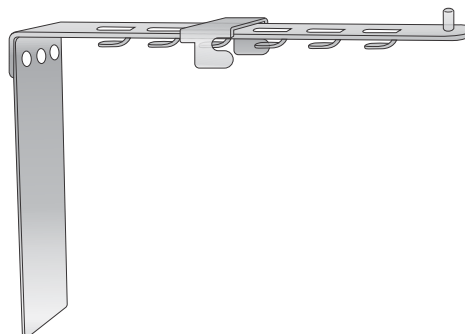

Code	Description
Sb-GI/522-B	Blade only - 38mm x 102mm

Blade C

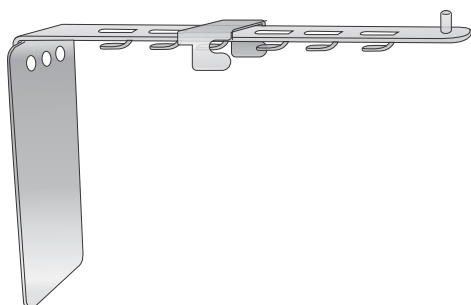

Code	Description
Sb-GI/522-C	Blade only - 57mm x 89mm

Blade D

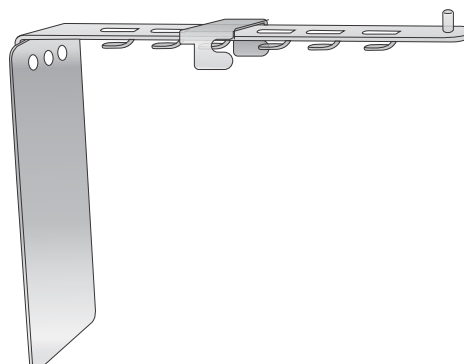

Code	Description
Sb-GI/522-D	Blade only - 57mm x 114mm



TURNER WARWICK RETRACTORS

STAHLÉAN BRAZIL
SAVING LIVES



Blade E

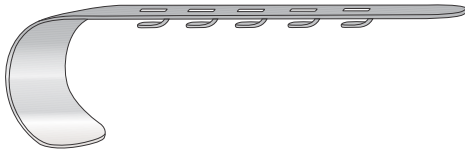

Code	Description
Sb-GI/522-E	Blade only - curved stainless steel blade 51mm x 38mm

Blade F

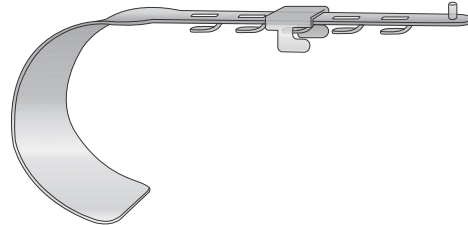

Code	Description
Sb-GI/522-F	Blade only - curved stainless steel blade 76mm x 60mm

Blade G

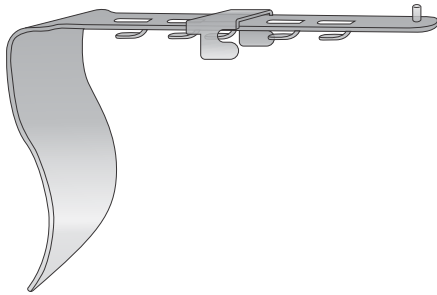

Code	Description
Sb-GI/522-G	Blade only - flat stainless steel blade 89mm x 60mm

Blade J



Code	Description
Sb-GI/522-J	Blade only - single hook, 13mm deep

Blade K

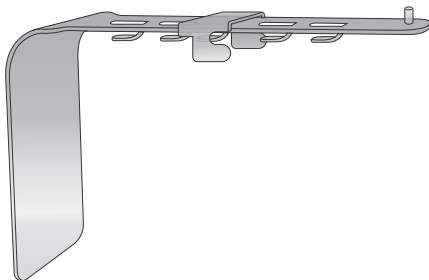

Code	Description
Sb-SC-GI/522-K	Blade only - flat with clip 55mm x 90mm

Blade L

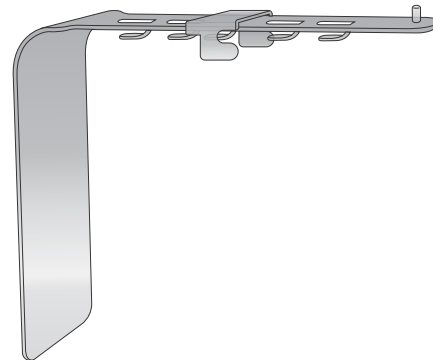

Code	Description
Sb-GI/522-L	Blade only - flat with clip 55mm x 120mm

RETRACTORS

STAHLÉAN BRAZIL
SAVING LIVES



Collin Retractor

110mm fully open, 235mm long

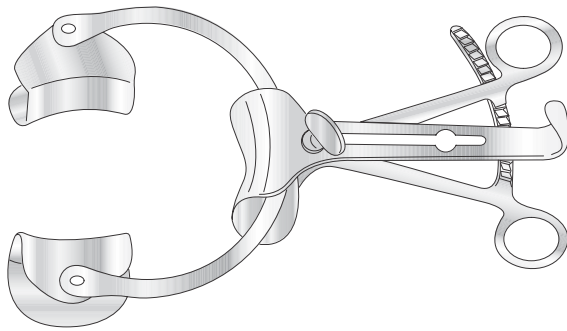

Code	Description
Sb-GI/322	Complete with centre blade 55 x 40mm and one pair of blades 38mm x 60mm
Sb-GI/322a	Without centre blade

Joll Thyroid Retractor

Self retaining, with lock-in nut

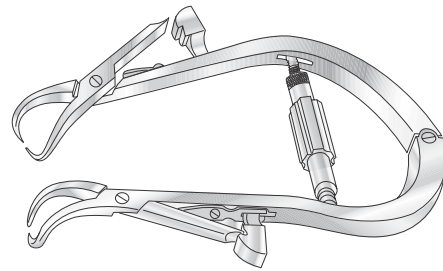

Code	Description
Sb-GI/363	152mm long

Gelpi Retractor

Self retaining

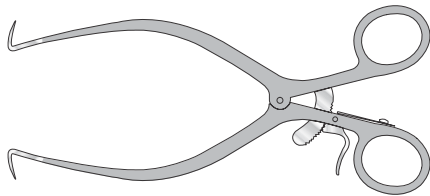

Code	Description
Sb-GY/013a	140mm long
Sb-GY/013b	178mm long

Gossett Abdominal Retractor

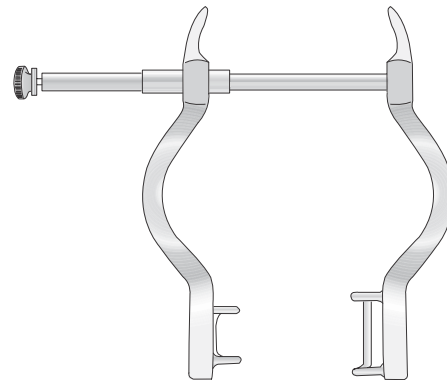

Code	Description
Sb-GI/303	Large, fully open 185mm long
Sb-GI/304	Small, fully open 95mm long

Pozzi Abdominal Retractors

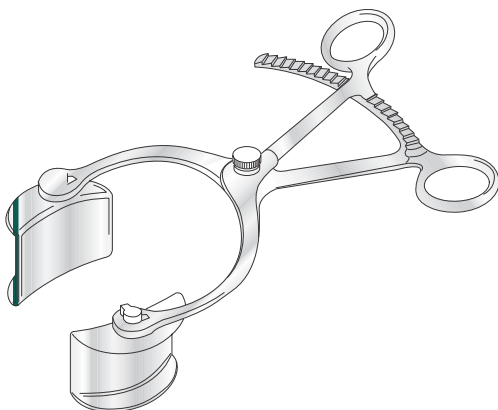

Code	Description
Sb-GI/370	Swivel blades: 38 x 60mm, bivalve, 254mm long

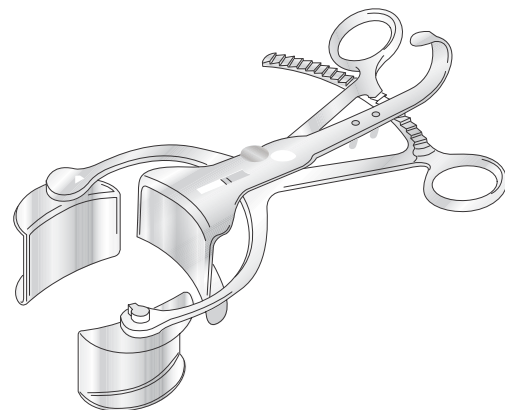

Code	Description
Sb-GI/371	Swivel blades: 38 x 59mm, trivalve, 203mm long

RETRACTORS

STAHLÉAN BRAZIL
SAVING LIVES



Bowlby Dilator

Curved

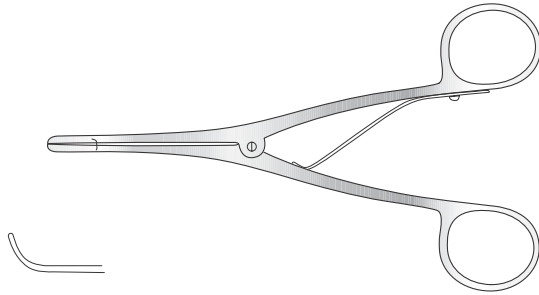

Code	Description
Sb-GI/495	145mm long

Travers Retractor

Self retaining with internal rack, 210mm long

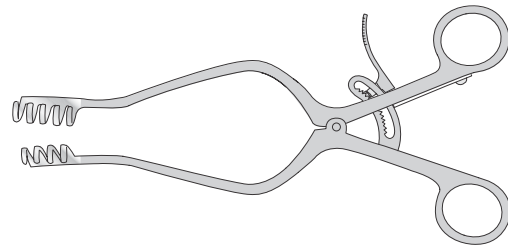

Code	Description
Sb-GI/323	4 x 5 teeth, 95mm fully open

Irwin Retractor

Self retaining, with cam rack, 4 x 4 teeth

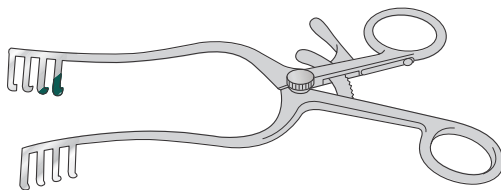

Code	Description
Sb-GI/324	178mm long

West Retractor

Self retaining, 140mm long

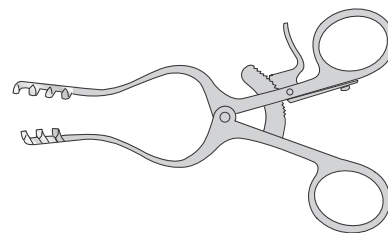

Code	Description
Sb-GI/326	3 x 4 teeth, 60mm fully open
Sb-GI/326cr	3 x 4 teeth, 60mm fully open, with cam rack

Norfolk and Norwich Retractor

4 x 5 teeth 50mm blades x 223mm long

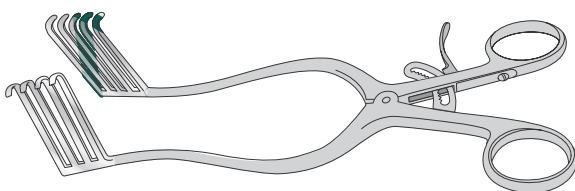

Code	Description
Sb-GI/325	Standard rack

Weitlander Retractor

3-4 teeth

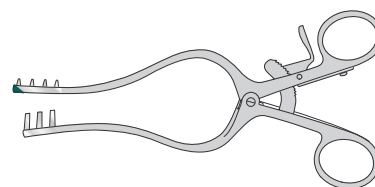

135mm long

Code	Description
Sb-GI/496	Blunt
Sb-GI/496a	Sharp
Sb-GI/496b	Sharp, 2-3 teeth
Sb-GI/496c	Blunt, 2-3 teeth

165mm long

Code	Description
Sb-GI/497	Blunt
Sb-GI/497a	Sharp

RETRACTORS

STAHLÉAN BRAZIL
SAVING LIVES



Kocher Retractor

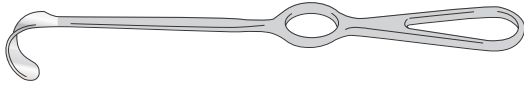

230mm long

Code	Description
Sb-GI/378	36 x 20mm blade

250mm long

Code	Description
Sb-GI/378a	67 x 25mm blade
Sb-GI/378b	80 x 42mm blade
Sb-GI/378c	80 x 50mm blade
Sb-GI/378d	80 x 60mm blade

Canny Ryall Navy Retractor

Double-ended, with one single hook blade 5mm wide, and one fenestrated blade

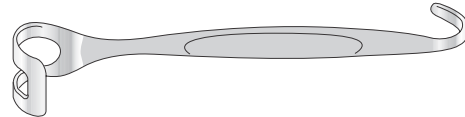

Code	Description
Sb-GI/343	Fenestrated blade 16mm wide, 190mm long
Sb-GI/343a	Fenestrated blade 19mm wide, 190mm long
Sb-GI/343b	Fenestrated blade 25mm wide, 220mm long
Sb-GI/343c	Fenestrated blade 30mm wide, 220mm long

Kocher Langenbeck Retractor

215mm long

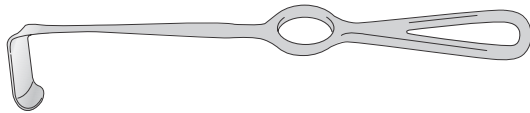

Code	Description	Code	Description
Sb-GI/336sp	25 x 6mm blade	Sb-THO/cutsp015	55 x 11mm blade
Sb-GI/379a	35 x 8mm blade	Sb-GI/379d	70 x 15mm blade
Sb-GI/379b	35 x 11mm blade	Sb-GI/379e	80 x 12mm blade
Sb-GI/379c	35 x 15mm blade	Sb-GI/379f	80 x 16mm blade
Sb-GI/357sp	41 x 11mm blade		

Canny Ryall Army Retractor

Double prong, 13mm wide, 165mm long



Code	Description
Sb-GI/342	Large, 19mm wide
Sb-GI/342a	Small, 11mm wide

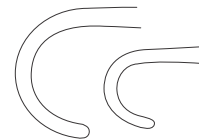

Langenbeck Retractor

Single ended



Code	Description
Sb-GI/336	Blade 22mm x 6mm
Sb-GI/337	Blade 45mm x 13mm
Sb-GI/337a	Blade 65mm x 13mm
Sb-GI/338a	Blade 75mm x 25mm
Sb-GI/338a1	Blade 65mm x 25mm

Czerny Retractor

Double ended

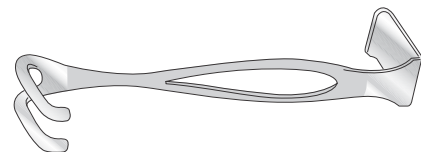

Code	Description
Sb-GI/341	171mm long

Landon Retractor

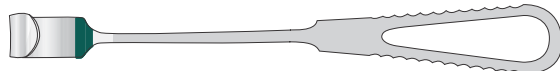

Code	Description
Sb-GI/494	230mm

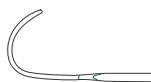

Lane Retractor

Double ended blade, 229mm long

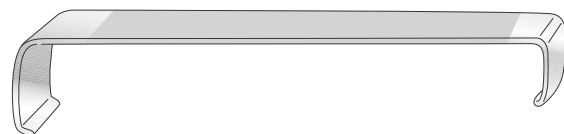

Code	Description
Sb-GI/339	13mm x 19mm wide
Sb-GI/340	25mm x 32mm wide

RETRACTORS

STAHLÉAN BRAZIL
SAVING LIVES



Kocher Retractor

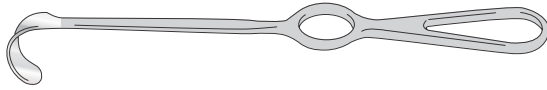

230mm long

Code	Description
Sb-GI/378	36 x 20mm blade

250mm long

Code	Description
Sb-GI/378a	67 x 25mm blade
Sb-GI/378b	80 x 42mm blade
Sb-GI/378c	80 x 50mm blade
Sb-GI/378d	80 x 60mm blade

Canny Ryall Navy Retractor

Double-ended, with one single hook blade 5mm wide, and one fenestrated blade

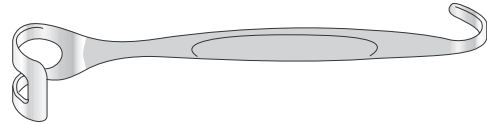

Code	Description
Sb-GI/343	Fenestrated blade 16mm wide, 190mm long
Sb-GI/343a	Fenestrated blade 19mm wide, 190mm long
Sb-GI/343b	Fenestrated blade 25mm wide, 220mm long
Sb-GI/343c	Fenestrated blade 30mm wide, 220mm long

Kocher Langenbeck Retractor

215mm long

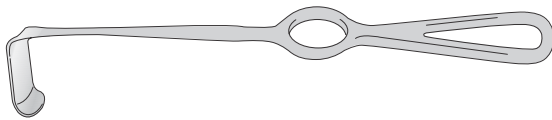

Code	Description
Sb-GI/336sp	25 x 6mm blade
Sb-GI/379a	35 x 8mm blade
Sb-GI/379b	35 x 11mm blade
Sb-GI/379c	35 x 15mm blade
Sb-GI/357sp	41 x 11mm blade

Code	Description
Sb-THO/cutsp015	55 x 11mm blade
Sb-GI/379d	70 x 15mm blade
Sb-GI/379e	80 x 12mm blade
Sb-GI/379f	80 x 16mm blade

Canny Ryall Army Retractor

Double prong, 13mm wide, 165mm long



Code	Description
Sb-GI/342	Large, 19mm wide
Sb-GI/342a	Small, 11mm wide

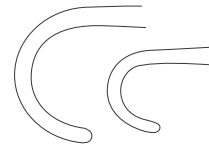

Langenbeck Retractor

Single ended

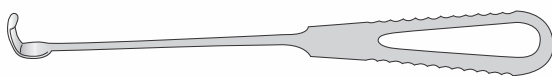

Code	Description
Sb-GI/336	Blade 22mm x 6mm
Sb-GI/337	Blade 45mm x 13mm
Sb-GI/337a	Blade 65mm x 13mm
Sb-GI/338a	Blade 75mm x 25mm
Sb-GI/338a1	Blade 65mm x 25mm

Czerny Retractor

Double ended

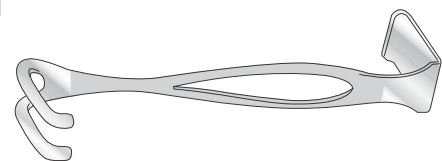

Code	Description
Sb-GI/341	171mm long

Landon Retractor

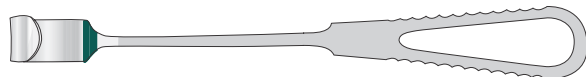

Code	Description
Sb-GI/494	230mm



Lane Retractor

Double ended blade, 229mm long

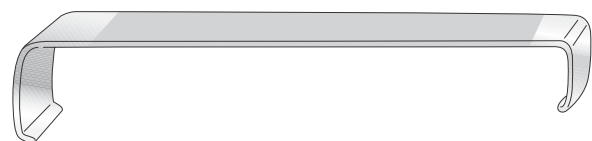

Code	Description
Sb-GI/339	13mm x 19mm wide
Sb-GI/340	25mm x 32mm wide

RETRACTORS

STAHLÉAN BRAZIL
SAVING LIVES



Morris Retractor

Single blade, 229mm long

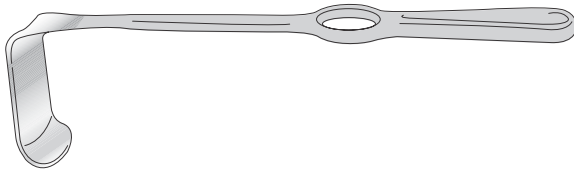

Code	Description
Sb-GI/330	38 x 51mm
Sb-GI/331	51 x 51mm
Sb-GI/332	64 x 51mm

Morris Retractor

Double ended, 216mm long

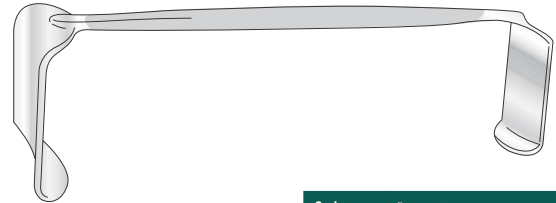

Code	Description
Sb-GI/327	32 x 51mm and 38 x 51mm
Sb-GI/328	44 x 51mm and 51 x 51mm
Sb-GI/329	64 x 51mm and 38 x 51mm

Moynihan Retractor

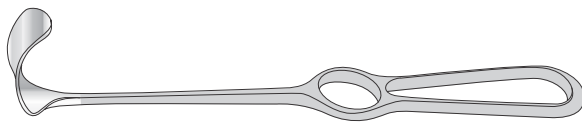

Code	Description
Sb-GI/462	Single ended, blade 13 x 22mm, 215mm long

Deaver Abdominal Retractors



Code	Description
Sb-GI/306	Set of 5, 315mm overall length
Sb-GI/307	25mm wide
Sb-GI/308	25mm wide
Sb-GI/309	38mm wide
Sb-GI/310	51mm wide
Sb-GI/311	76mm wide

Elliot (Modified Deaver) Retractor

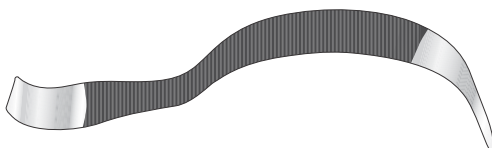

Code	Description
Sb-GI/308M	With flat handle

Dyball and Lock Retractor

For liver

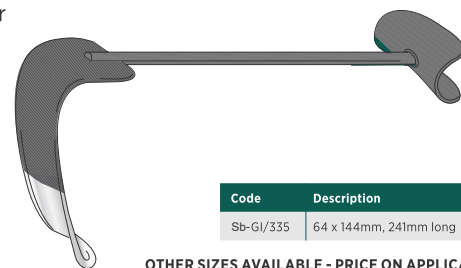

Code	Description
Sb-GI/335	64 x 144mm, 241mm long

OTHER SIZES AVAILABLE - PRICE ON APPLICATION

Deaver Abdominal Retractors

With round handles

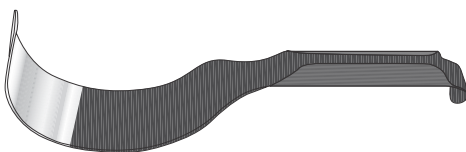

Code	Description
Sb-GI/312	Set of 5, 305mm overall length
Sb-GI/313	25mm wide
Sb-GI/314	25mm wide
Sb-GI/315	38mm wide
Sb-GI/316	51mm wide
Sb-GI/317	76mm wide

Kelly Retractor Blade

267mm long



Code	Description
Sb-GI/333	38 x 191mm
Sb-GI/334	57 x 191mm

RETRACTORS

STAHLÉAN BRAZIL
SAVING LIVES



Durham Retractor

With fenestrated blade, 216mm long

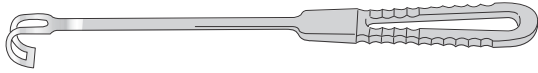

Code	Description
Sb-GI/300	10mm wide
Sb-GI/301	14mm wide
Sb-GI/302	20mm wide

Ballance (Volkman) Retractor

203mm long

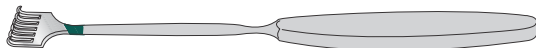

Sharp

Code	Description
Sb-GI/463	1 prong
Sb-GI/463a	2 prong
Sb-GI/463b	3 prong
Sb-GI/463c	4 prong
Sb-GI/463d	6 prong

Blunt

Code	Description
Sb-GI/463e	1 prong
Sb-GI/463f	2 prong
Sb-GI/463g	3 prong
Sb-GI/463h	4 prong
Sb-GI/463i	6 prong

Volkman Retractor



Code	Description
Sb-OR/400	Sharp, 220mm long
Sb-OR/400a	Blunt, 220mm long
Sb-OR/400b	Sharp, 245mm long

Kilner Retractor

Double ended, cat's paw

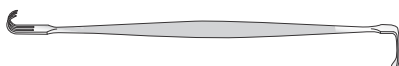

Code	Description
Sb-PL/056	152mm long

Kocher Retractor

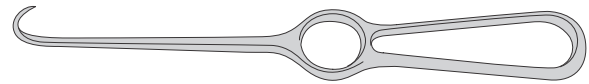

Code	Description
Sb-OR/N036c	Sharp, 205mm long
Sb-OR/N036	Sharp, 220mm long
Sb-OR/N036b	Blunt, 220mm long

Senn-Miller Retractor

170mm long



Code
Sb-SH/5881

Single Hook Retractor

Sharp



Code	Description
Sb-GI/SH5671	152mm long
Sb-PL/065b	Half size, fine

Gillies Skin Hook

Solid handle, 190mm long



Code	Description
Sb-PL/065a	Standard, fine
Sb-PL/065b	Half size, fine

DISSECTORS AND PROBES

STAHLÉAN BRAZIL
SAVING LIVES



MacDonald Dissector Double Ended



Code	Description
Sb-GI/285	191mm long

Probe, Sinus Silver



Code	Description
Sb-GI/464	152mm long

Brodie Director Probe Ended, Silver Plated



Code	Description
Sb-GI/286	165mm long

Probe, Fish Tail Silver Plated



Code	Description
Sb-GI/293	127mm long
Sb-GI/294	152mm long
Sb-GI/295	203mm long
Sb-GI/296	254mm long

Watson Cheyne Dissector

Fine, double-ended, with probe end



Code	Description
Sb-GI/287	127mm long
Sb-GI/288	191mm long
Sb-GI/288a	230mm long
Sb-GI/288b	255mm long

Jobson Horne Probe Dressing (Aural)

With one flat tapered end, serrated edge and one small ring end, stainless steel



Code	Description
Sb-GI/297	140mm long
Sb-GI/298	178mm long

Probe, Malleable Silver Plated



Code	Description
Sb-GI/289a	127mm long
Sb-GI/289	152mm long
Sb-GI/290	178mm long
Sb-GI/291	203mm long
Sb-GI/292	255mm long
Sb-GI/292a	305mm long

Stahleanbrazil

A table-fixed retractor system designed by surgeons to efficiently and reliably hold surgical instruments in place during surgery while allowing greater visibility.

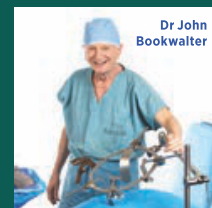

Table Post and Coupling, Horizontal Flex Bar, Segmented Rings, Tilt Ratchet Mechanism, Kelly Retractors, Blades and Ratchets

MISCELLANEOUS

STAHLÉAN BRAZIL
SAVING LIVES



Aneurysm Needle

Small, for infusions



Code	Description
Sb-GI/472a	146mm long

Syme Aneurysm Needle

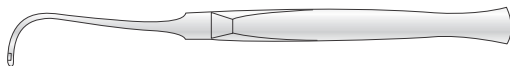

Code	Description
Sb-GI/473	165mm long

Ring Cutter

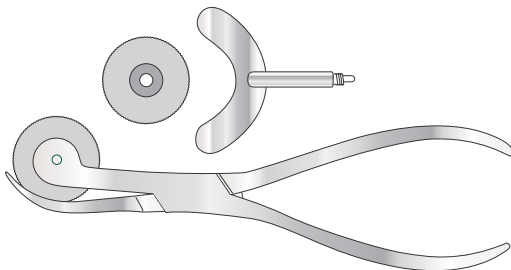

Code	Description
Sb-GI/452	Circular saw blade, 165mm long
Sb-GI/452a	Spare blade

Mayo Instrument Pin

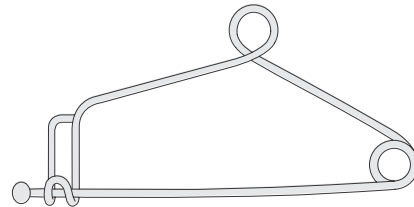

Code	Description
Sb-GI/355	102mm long
Sb-GI/356	152mm long

Baron Scalpel Handle

130mm long



Code	Description
Sb-PM/003	No 3
Sb-PM/004	No 4

Scalpel Handle

127mm long



Code	Description
Sb-PM/007	No 3
Sb-PM/008	No 4
Sb-PM/008a	No 4 L
Sb-PM/001a	No 7

Endoscope Re-fibre

Stahleánbrazil manufacture their own fibre bundles in house. We cover small and larger diameter scopes and only use high quality German fibre optic material and stainless steel tubing.

- Quality components, globally sourced:
- ✓ Medical grade stainless steel tubing
 - ✓ German engineered new glass fibre
 - ✓ New fibre cone as standard
 - ✓ New solderable sapphire distal window
 - ✓ New light post colour ring
 - ✓ New objective in 95% of cases
 - ✓ Replacement 'O' ring to prevent leakage

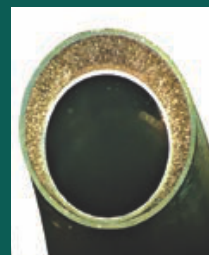

After repair



Before repair

HOLLOW WARE

STAHLÉAN BRAZIL
SAVING LIVES



Kidney Dish

Stainless steel

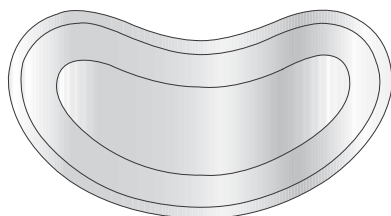

Code	Description
Sb-GI/380	152mm
Sb-GI/381	203mm
Sb-GI/382	254mm
Sb-GI/383	305mm

Cheate Jar



Code	Description
Sb-GI/397	Stainless steel, 203mm x 50mm

Lotion Bowl

Without lid, stainless steel

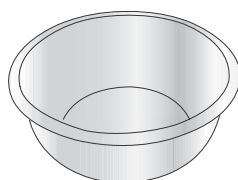

Code	Description
Sb-GI/384	102mm
Sb-GI/385	152mm
Sb-GI/386	203mm
Sb-GI/387	254mm
Sb-GI/388	305mm

Measuring Jug



Code	Description
Sb-GI/395	1 litre capacity

Instrument Tray

Stainless steel

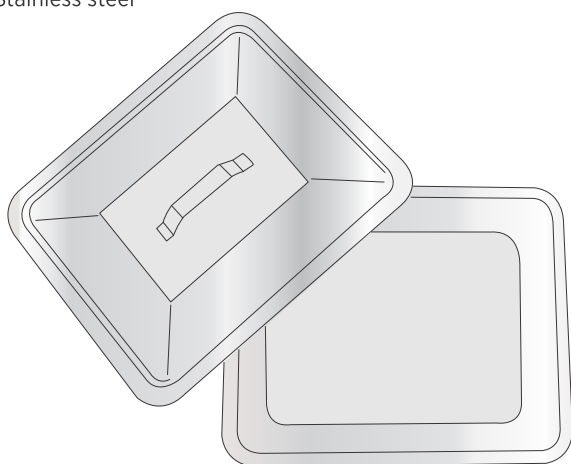

Code	Description
Sb-GI/389	254 x 203 x 50mm
Sb-GI/390	Lid only for 254 x 203 x 50mm
Sb-GI/391	305 x 254 x 50mm
Sb-GI/392	Lid only for 305 x 254 x 50mm
Sb-GI/393	356 x 305 x 50mm
Sb-GI/394	Lid only for 356 x 305 x 50mm

Petri Dish



Code	Description
Sb-SH/002149	100mm, stainless steel, with lid

Gallipot

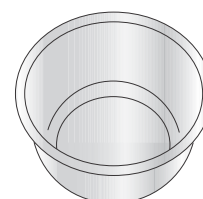

Code	Description
Sb-GI/396	Stainless steel, 63mm

SILICONE MATTING & STERILISING BASKETS

Silicone Matting

Medical grade for storage, sterilisation and transportation of instruments.

Cushion, protect, and organise delicate surgical instruments during storage, transportation, and sterilisation. Perforations allow for ventilation during the sterilisation process. The silicone mat can be cut to fit any size container.

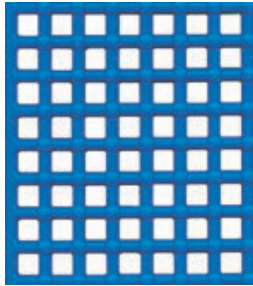

502mm long x 242mm wide
7mm holes, 10mm between holes

Code
SI/1004M

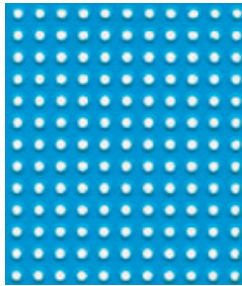

515mm long x 240mm wide
3mm holes, 6mm between holes

Code
SI/1001M

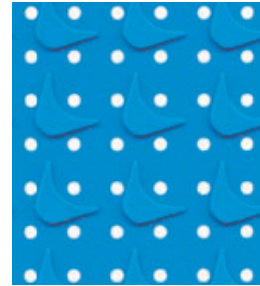

570mm long x 550mm wide
4mm holes, 13mm between holes

Code
SI/1002M

Sterilising Baskets

DIN Basket

Wire mesh base with perforated sides and two carrying handles

Code	Description
Sb-GI/CO006	230 x 130 x 60mm
Sb-GI/CO007	240 x 130 x 50mm
Sb-GI/CO008	240 x 130 x 60mm
Sb-GI/CO009	240 x 250 x 50mm
Sb-GI/CO010	240 x 250 x 60mm
Sb-GI/CO014	300 x 300 x 50mm
Sb-GI/CO015	350 x 350 x 60mm
Sb-GI/CO011	480 x 250 x 50mm
Sb-GI/CO012	480 x 250 x 60mm

Code	Description
Sb-GI/CO013	480 x 250 x 70mm
Sb-GI/CO016	480 x 400 x 60mm
Sb-GI/CO017	480 x 480 x 50mm
Sb-GI/CO018	480 x 480 x 60mm
Sb-GI/CO019	500 x 300 x 50mm
Sb-GI/CO020	550 x 430 x 50mm
Sb-GI/CO021	600 x 300 x 60mm



DIN Basket

Wire mesh basket with two carrying handles

Code	Description
Sb-GI/CO022	240 x 250 x 50mm
Sb-GI/CO023	240 x 250 x 60mm
Sb-GI/CO024	240 x 250 x 70mm
Sb-GI/CO031	300 x 300 x 60mm
Sb-GI/CO025	480 x 250 x 50mm

Code	Description
Sb-GI/CO026	480 x 250 x 60mm
Sb-GI/CO027	480 x 250 x 70mm
Sb-GI/CO028	480 x 250 x 100mm
Sb-GI/CO029	480 x 480 x 50mm
Sb-GI/CO030	480 x 480 x 70mm

DIN Basket Lids

For perforated and wire mesh baskets

Code	Description
Sb-GI/CO032	240 x 250mm
Sb-GI/CO033	300 x 300mm
Sb-GI/CO034	480 x 250mm
Sb-GI/CO035	480 x 480mm

Did you know...

Organising and fixing instruments in place can aid the cleaning process.

Help keep your instruments in good condition for longer with our baskets and trays. Available in custom sizes, to suit your requirements perfectly.

STERILISING BASKETS

STAHLÉAN BRAZIL
SAVING LIVES



ENT Basket

Wire mesh base with perforated sides and two carrying handles, supplied with lid

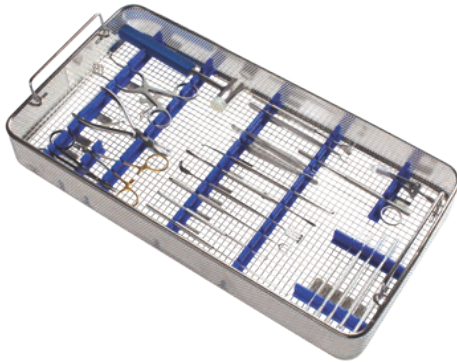

Code	Description
Sb-GI/CO036	480 x 250 x 160mm
Sb-GI/CO037	Fixing clamps

Arthroscope Basket

Wire mesh base with two fixing clamps

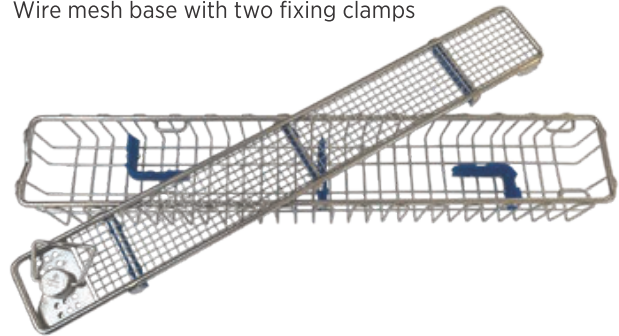

Code	Description
Sb-GI/CO001	290 x 80 x 52mm

Endoscope Basket

With small lens basket

Code	Description
Sb-GI/CO002	6400 x 150 x 77mm

Wire mesh base with two fixing clamps

Code	Description
Sb-GI/CO003	S - 460 x 80 x 52mm
Sb-GI/CO004	D - 480 x 80 x 52mm
Sb-GI/CO005	D - 680 x 80 x 52mm

Sieve

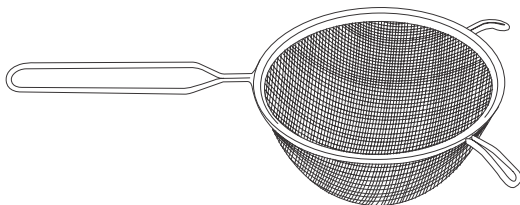

Code	Description
Sb-GI/5071	203mm x 50mm ø

Fine Mesh Basket



With hinged take off / lockable lid

Code	Description
Sb-GI/CO041	120 x 155 x 40mm
Sb-GI/CO044	120 x 155 x 50mm
Sb-GI/CO042	235 x 155 x 40mm
Sb-GI/CO045	235 x 155 x 50mm
Sb-GI/CO043	375 x 260 x 40mm

With separate lid

Code	Description
Sb-GI/CO038	120 x 155 x 40mm
Sb-GI/CO039	235 x 155 x 40mm
Sb-GI/CO040	375 x 260 x 40mm

Stahleanbrazil Quadlock Containers



Stahleanbrazil offer the unique Quadlock container. The Patented design offers 4 locks, as opposed to the traditional 2, to ensure extra security and peace of mind.

OPTICAL FIBRE CABLES

STAHLÉAN BRAZIL
SAVING LIVES

Our optical fibre cables are compatible with all major scopes and illuminators. Every light lead is high temperature xenon compatible, rated to the highest level of thermal resistance and tested to ensure the highest light output possible.



Choice of 10 colours for easy identification



Choice of lengths and sheathing types

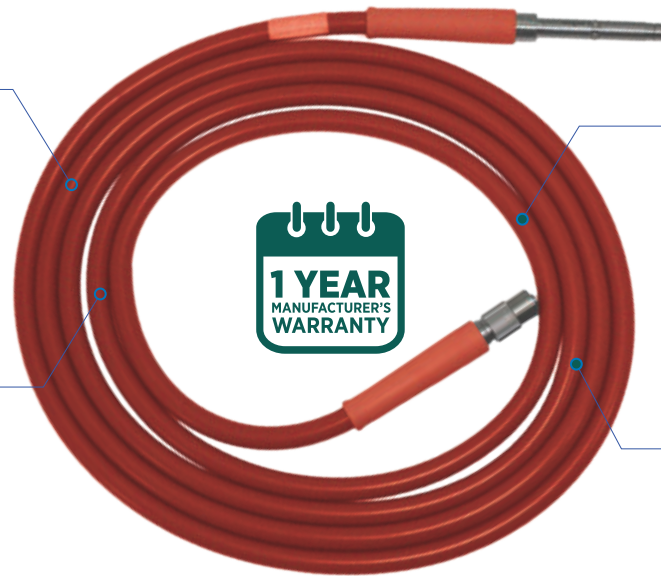

Free on-site light lead testing

We'll come and go through your lead stock to ensure your leads are fit for use



Reinforced for longer life

How to order

Select an option from each of the following steps to create your part number.

Part number = _____
Step 1 Step 2 Step 3 Step 4 Step 5 Step 6 Step 7

Example: 474810180FRGY is a Storz Proximal, Storz Distal, 4.8mm Bundle, 254mm Length, Fully Reinforced Sheathing in Grey

Step 1: Proximal

All end tips are stainless steel

ACMI



Ø 0.299

1

Wolf/Dyonics

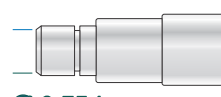

Ø 0.354

2

Long Wolf



Ø 0.354

L2

Olympus/ACMI

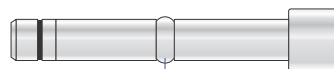

Retaining ring

3

Storz



4

Pilling

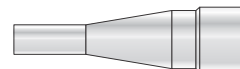

5

Universal



3/8-24 or 5/16-24 thread

U

OPTICAL FIBRE CABLES

STAHLÉAN BRAZIL
SAVING LIVES



Step 2: Distal

All end tips are stainless steel

Wolf Snap On

6



Storz

7

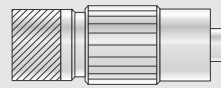

ACMI Snap-On

8

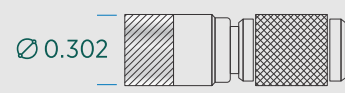

Olympus

9

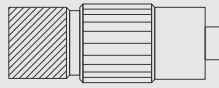

Wolf Clip-On

10



Pilling

11

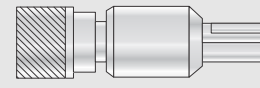

ACMI Clip-On

12

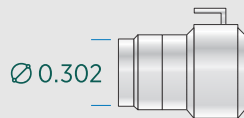

Mini Olympus

13

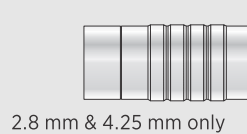

Universal

U

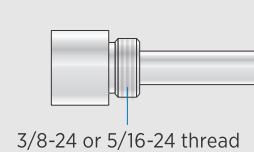

Step 3: Bundle Size

Place gauge on bundle to determine diameter

2.2mm 22

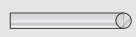

2.8mm 28

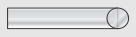

Mini Olympus only

3.0mm 30

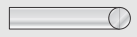

3.8mm 38

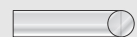

4.25mm 425



Mini Olympus only

4.8mm 48

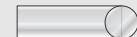

Step 4: Length

6ft

6

8ft

8

10ft

10

Call us for custom lengths

Step 5: Connector Angle

180°

180

45°

45

90°

90

Step 6: Sheathing Type

Non-reinforced

0

6" Reinforced*

6

Fully Reinforced*

FR

*Reinforced options are not available with clear sheathing

Step 7: Sheathing Colour

Black



BK

Blue



BL

Clear



CL

Green



GR

Gray



GY

Red



RD

Pink

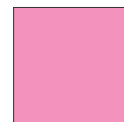

PK

White

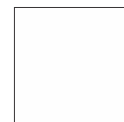

WH

Yellow



YL

4.8mm only



STAHLÉAN BRAZIL

SAVING LIVES

CONTACT US

Office in são paulo

 +5511 972111007

 +92-3347711007

 @stahleanbrazil

 info@stahleanbrazil.com

 www.stahleanbrazil.com